

SEVERIN

MANUAL

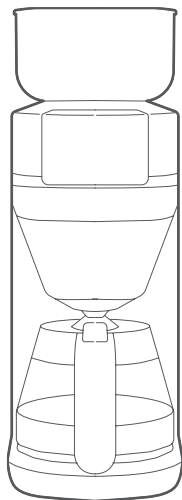

Art.-No. KA 4852, 4853, 4854, 4855

DE GB FR NL ES IT

DE	Gebrauchsanleitung.....	3
GB	Instruction manual.....	20
FR	Mode d'emploi.....	37
NL	Gebruikshandleiding.....	54
ES	Instrucciones de uso.....	71
IT	Istruzioni per l'uso.....	88

Inhalt

1	Zu dieser Anleitung	4
2	Lieferumfang.....	5
3	Anzeige und Bedienfeld	6
4	Vor der ersten Inbetriebnahme	7
	Auspacken	7
	Reinigung.....	7
	Aufstellen	7
	Einstellungen	7
	Sprache zurücksetzen	9
5	Kaffeezubereitung.....	12
6	Reinigung & Pflege.....	13
	Entkalken.....	13
	Reinigen.....	14
7	Transport / Lagerung	16
8	FAQ.....	17
9	Zubehör	18
10	Entsorgung.....	19
11	Technische Daten	19

DE

GB

FR

NL

ES

IT

1 Zu dieser Anleitung

Allgemeine Hinweise

DE

Diese Anleitung ist Bestandteil des Geräts.

- ▶ Vor Aufstellung, Installation und Inbetriebnahme des Geräts sorgfältig lesen und aufbewahren.
- ▶ An jeden nachfolgenden Bediener weitergeben.

GB

Das Gerät darf nur von Personen benutzt werden, die mit den Sicherheitshinweisen vertraut sind.

FR

Mitgelieferte Dokumente

NL

- Quickstart Guide
- Sicherheits-Handbuch (Safety)
- Garantieerklärung (Warranty)

ES

IT

Darstellung von Warnhinweisen



Signalwort

Art, Quelle und Folge der Gefahr

- ▶ Maßnahmen zur Vermeidung der Gefahr.

Signalwort	Bedeutung
Gefahr	Unmittelbar bevorstehende Gefahr, die zum Tod oder zu schwerer Verletzung führt, wenn sie nicht vermieden wird.
Warnung	Möglicherweise bevorstehende Gefahr, die zum Tod oder zu schwerer Verletzung führen kann, wenn sie nicht vermieden wird.
Vorsicht	Möglicherweise bevorstehende Gefahr, die zu leichter Verletzung führen kann, wenn sie nicht vermieden wird.
Hinweis	Möglicherweise bevorstehende Gefahr, die zu Sachschäden führen kann, wenn sie nicht vermieden wird.

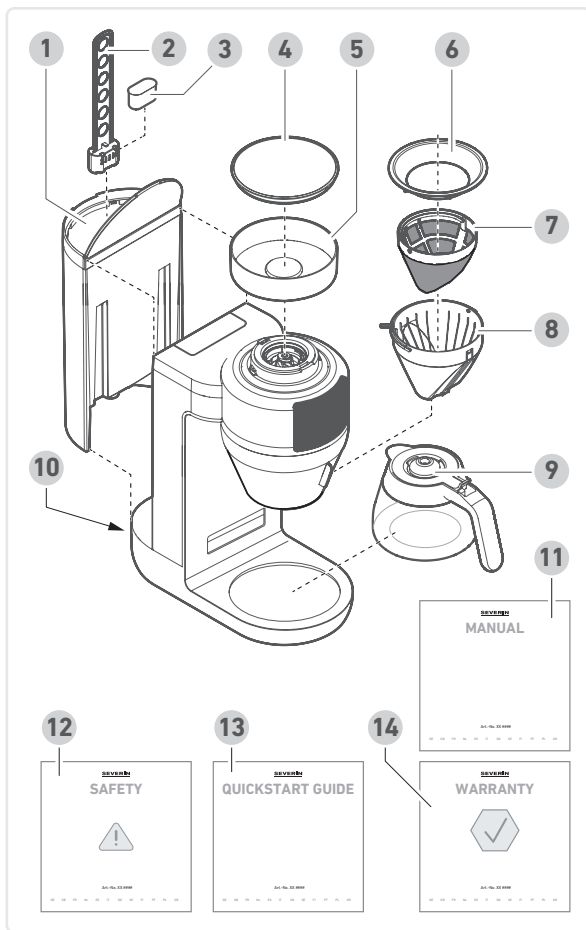

2 Lieferumfang

- 1 Wassertank
- 2 Wasserfilterhalterung
- 3 Wasserfilterpatrone
- 4 Deckel Bohnenbehälter
- 5 Bohnenbehälter
- 6 Filterring
- 7 Goldtonfilter
- 8 Filtereinsatz
- 9 Kanne
- 10 Ein-/Aus-Schalter
- 11 Gebrauchsanleitung
- 12 Sicherheitshinweise
- 13 Quickstart Guide
- 14 Garantieerklärung

DE

GB

FR

NL

ES

IT



www.severin.com

3 Anzeige und Bedienfeld

DE

GB

FR

NL

ES

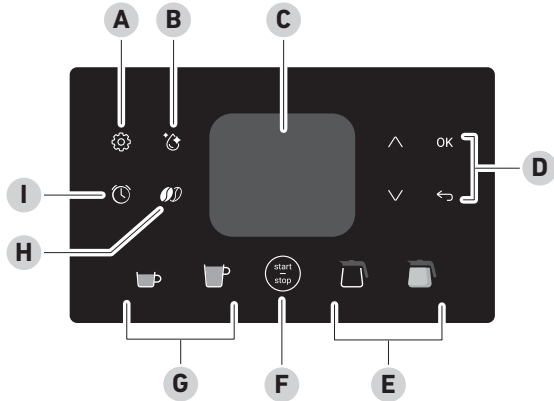
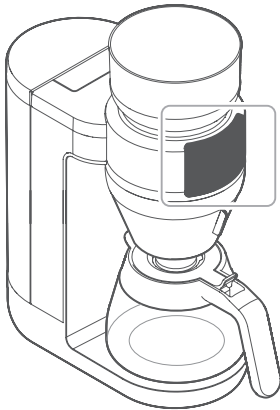

IT



A Einstellungen: Bohnen / Pulver, Signaltöne, Wasserfilter, Wasserhärte, Uhrzeit, Anleitung, Sprache, Expert, Warmhalten, Zurücksetzen

B Reinigung: Spülen, Entkalken, Pulverausgabe

C Displayanzeige

D Navigation:   zum Anwählen der verschiedenen Einstellungsoptionen, **OK** zum Bestätigen,  zum vorherigen Menüpunkt zurückkehren oder Menü verlassen

E Kannenart: Glaskanne oder Thermokanne (je nach Variante)

F start - stop: zum Starten und Stoppen der Kaffeeausgabe, zum Aktivieren im Standby Modus

G Tassengröße: Tasse klein: 100 - 150 ml, Tasse groß: 175 -350 ml in 25 ml Schritten

H Kaffeestärke

I Wecker

4 Vor der ersten Inbetriebnahme

Auspacken

- ▶ Alle Teile aus der Verpackung entnehmen.
- ▶ Verpackungsmaterial, Schutzfolien und Aufkleber vollständig entfernen.
 - ! **Typenschilder nicht entfernen, diese müssen immer am Gerät bleiben.**
- ▶ Lieferumfang auf Vollständigkeit und Mängel prüfen.

Reinigung

- ▶ Alle Zubehöerteile reinigen, siehe Kapitel 6 Reinigung & Pflege.
- ▶ Drei Spülgänge durchführen, siehe Seite 14, *Spülen*.

Aufstellen

- ▶ Gerät auf trockene, wasserfeste und wärmebeständige Standfläche stellen.
- ▶ Gerät nicht direkt auf Marmor oder Holz stellen (Gefahr von Kaffee-/Entkalkerflecken).
- ▶ Gerät von heißen Oberflächen (z. B. Herdplatten) fernhalten.
- ▶ Netzstecker in Schutzkontaktsteckdose einstecken.
- ▶ Gerät mit dem Schalter an der unteren Geräterückseite einschalten.







Einstellungen

Vor der ersten Inbetriebnahme oder nach dem Zurücksetzen auf Werkseinstellung erfolgt am Display eine Einführung in die Gerätefunktionen und auswählbaren Symbole. Dazu den Anweisungen am Display folgen.

Alternativ können die Einstellungen wie folgt geändert werden:

Einstellungen allgemein

Signaltöne

- ▶ Am Display  auswählen.
- ▶ Mit   zu **Signaltöne** wechseln und mit  bestätigen.
- ▶ Den Anweisungen auf dem Display folgen, mit  bestätigen und mit  ins Hauptmenü zurückkehren.

DE

GB

FR

NL

ES

IT

Wasserfilter

Das Gerät kann mit und ohne Wasserfilter verwendet werden.

Bei Betrieb ohne Wasserfilter Einstellung Wasserhärte anpassen, *Wasserhärte* siehe Seite 8, *Wasserhärte*.

DE

Wasserfilter alle 2 Monate oder nach einer Kaffeemenge von ca. 50 l wechseln.

GB

- ▶ Filterpatrone in Halterung einlegen.
- ▶ Wasserfilter-Halterung in leeren Wassertank einsetzen.

FR

- ▶ Wassertank mit Wasser füllen und min. 10 Minuten bis zur Benutzung warten.

NL

- ▶ Am Display  auswählen.

ES

- ▶ Mit   zu **Wasserfilter** wechseln und mit **OK** bestätigen.



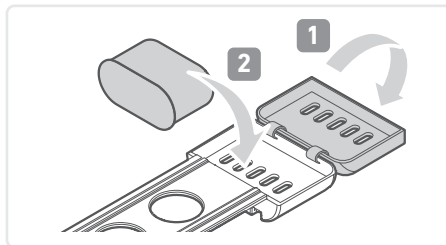

IT

- ▶ Den Anweisungen auf dem Display folgen, mit **OK** bestätigen und mit  ins Hauptmenü zurückkehren.



Wasserhärte

Die Wasserhärte nur einstellen, wenn kein Wasserfilter verwendet wird.

- ▶ Am Display  auswählen.
- ▶ Mit   zu **Wasserhärte** wechseln und mit **OK** bestätigen.
- ▶ Den Anweisungen auf dem Display folgen, mit **OK** bestätigen und mit  ins Hauptmenü zurückkehren.

Wasserhärte



weich







mittel





hart





Uhrzeit

- ▶ Am Display  auswählen.
- ▶ Mit   zu **Uhrzeit** wechseln und mit **OK** bestätigen.
- ▶ Den Anweisungen auf dem Display folgen, mit **OK** bestätigen und mit  ins Hauptmenü zurückkehren.

Anleitung

- ▶ Am Display  auswählen.
- ▶ Mit   zu **Anleitung** wechseln und mit **OK** bestätigen.
- ▶ QR-Code scannen und die Anleitung aufrufen.





Sprache

- ▶ Am Display  auswählen.
- ▶ Mit   zu **Sprache** wechseln und mit **OK** bestätigen.
- ▶ Den Anweisungen auf dem Display folgen, mit **OK** bestätigen und mit  ins Hauptmenü zurückkehren.

Zurücksetzen auf Werkseinstellung (Standard-Einstellungen)

- ▶ Am Display  auswählen.
- ▶ Mit   zu **Zurücksetzen** wechseln und zweimal mit **OK** bestätigen.

Falsche Sprache ausgewählt?:

- ▶ Mit  zurück ins Hauptmenü.
- ▶  drücken, mit   bis ganz nach unten navigieren (grauer Balken im Display ganz unten) und zweimal mit **OK** bestätigen.

Falls diese Lösung nicht funktioniert, bitte so oft **OK** drücken, bis das Hauptmenü angezeigt wird. Dann  drücken und wie oben angegeben vorgehen.

Die Geräteeinstellungen werden zurückgesetzt und die Sprache kann erneut ausgewählt werden.

Standby Modus

Nach 5 Minuten wechselt das Gerät in Standby.

Am Display sind nur Uhrzeit und  sichtbar.

- ▶  antippen oder den Filter aufschwenken, um den Standby Modus zu verlassen.

DE

Einstellungen Kaffe Zubereitung

GB

Bohnen/Pulver

FR

- ▶ Am Display  auswählen.

- ▶ Zu **Bohnen / Pulver** navigieren und mit **OK** bestätigen.

NL

- ▶ **Bohnen** oder **Pulver** auswählen, mit **OK** bestätigen und mit  ins Hauptmenü zurückkehren.

ES

Kaffeestärke

IT

Die Kaffeestärke kann bei der Verwendung von Kaffeebohnen nach Auswahl des Gefäßes in 5 Stufen eingestellt werden:

- ▶ Durch Drücken der Taste  die Kaffeestärke ändern und mit  die Zubereitung starten.

Expert

Im Expert-Modus kann die Kaffeestärke noch individueller eingestellt werden.

Die Werkseinstellung beträgt 100 %. Je geringer die Einstellung ist, umso milder wird der Kaffee.



Hinweis!

Schäden am Gerät, Oberflächen und Möbeln durch Überlaufen des Filters.

- ▶ Bei einer Einstellung von >130 % darf die Tassenanzahl bei Zubereitung mit Kanne maximal 6 betragen.

- ▶ Am Display  auswählen.

- ▶ Mit   zu **Expert** wechseln und mit **OK** bestätigen.

- ▶ Den Anweisungen auf dem Display folgen, mit **OK** bestätigen und mit  ins Hauptmenü zurückkehren.

Mahlgrad



Hinweis!

Eine Änderung des Mahlgrads bei inaktivem Mahlwerk kann zu Beschädigungen am Gerät führen.

- ▶ Mahlgrad nur bei aktivem Mahlwerk ändern.

Der Mahlgrad kann stufenlos eingestellt werden.

- ▶ Markierung auf Bohnenbehälter auf gewünschten Mahlgrad drehen, während das Mahlwerk aktiv ist.

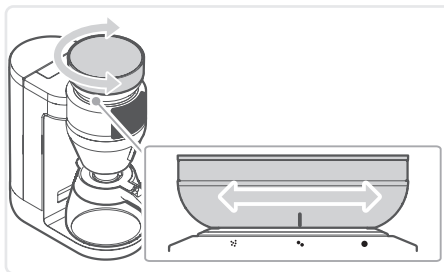

Wecker

Für Nutzung der „Wecker“-Funktion muss die Uhrzeit richtig eingestellt sein.

Bei aktivierter Wecker-Funktion wird zur angegebenen Uhrzeit Kaffee mit eingestellter Menge ausgegeben. Zum Zeitpunkt der Zubereitung muss das Gerät korrekt zusammengesetzt, Kaffeebohnen oder -pulver und Wasser muss in ausreichender Menge eingefüllt sein und ein geeignetes Gefäß muss unter dem Auslauf stehen.

- ▶ Am Display auswählen.
 - ▶ Den Anweisungen auf dem Display folgen, mit **OK** bestätigen und mit ins Hauptmenü zurückkehren.
- Für erneute Wecker-Nutzung muss die Funktion wieder aktiviert werden. Die Einstellungen bleiben erhalten.

Warmhalten

Die Warmhalte-Funktion mit Glaskanne startet nach dem Brühvorgang automatisch. Die Dauer ist ab Werk auf 30 Minuten eingestellt. Zum einmaligen Ändern der Dauer (15-60 Minuten) drücken. Für eine dauerhafte Änderung der Warmhaltezeit am Display auswählen. Mit zu **Warmhalten** wechseln und mit **OK** bestätigen. Den Anweisungen auf dem Display folgen, mit **OK** bestätigen und mit ins Hauptmenü zurückkehren.

Alternativ kann die Warmhaltefunktion im Hauptmenü durch langen Druck auf gestartet werden.

DE

GB

FR

NL

ES

IT

5 Kaffeezubereitung



Warnung!

Verbrühungsgefahr.

▶ Keine Körperteile unter Auslauf halten, während Gerät in Betrieb ist.

DE

GB

FR





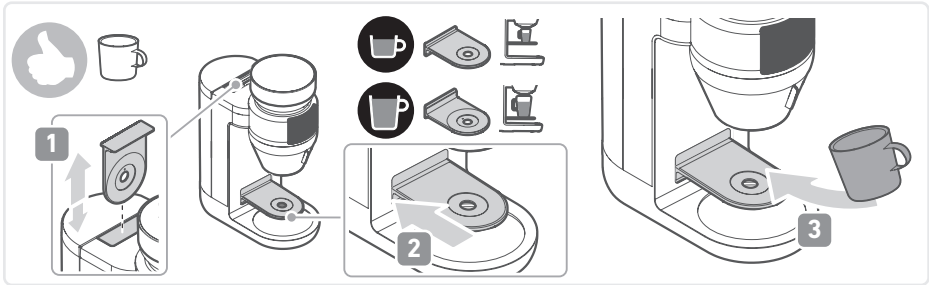
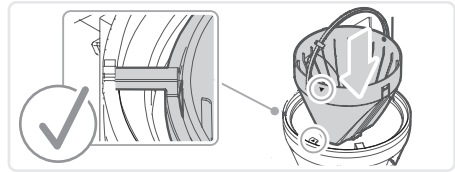

NL

ES

IT

- ▶ Wassertank mit maximal 2000 ml kaltem Leitungswasser füllen.
- ▶ Filtereinsatz einsetzen.
- ▶ Goldtonfilter oder Einwegfilter einsetzen.
- ▶ Filterring auflegen.
- ▶ Je nach gewählter Zubereitungsart Bohnen in Bohnenbehälter oder Kaffeepulver in Kaffeefilter einfüllen.
- ▶ Gewünschtes Gefäß unter Auslauf stellen.



- ▶ Am Display Gefäß auswählen:    .
- ▶ Menge und eventuell Kaffeestärke einstellen.
- ▶ Brühvorgang mit  starten.
- ▶ Zum Abbrechen des Brühvorgangs Taste  erneut drücken.

6 Reinigung & Pflege

Entkalken

Das Gerät muss je nach Kalkgehalt des Wassers und Benutzungshäufigkeit entkalkt werden. Der Garantieanspruch erlischt bei Geräten, die aufgrund mangelnder Entkalkung nicht einwandfrei funktionieren.

Im Display leuchtet  rot, wenn das Gerät entkalkt werden muss.

Der Entkalkungsvorgang dauert ca. 20 Minuten.

Für das Entkalken werden 70 ml Essig-Essenz und 930 ml Wasser benötigt.

Alternativ 1 l Entkalkungsmittel.



Vorsicht!

Entkalkungsmittel nicht in emaillierte oder andere säureempfindliche Abflussbecken gießen. Diese können Schaden nehmen.

- ▶ Sicherstellen, dass das Abflussbecken für die verwendeten Entkalkungsmittel ausgelegt ist.
- ▶ Entkalkungsmittel fachgerecht entsorgen.



Warnung!

Während der Entkalkung entsteht Essigdampf. Dieser ist gesundheitsschädlich, wenn er eingeatmet wird.

- ▶ Während der Entkalkung für ausreichende Lüftung sorgen und den Essigdampf nicht einatmen.

DE

GB



FR

NL

ES

IT

Entkalkungsvorgang starten

- ▶ Taste  auf Display auswählen.
- ▶ Mit   zu **Entkalken** wechseln und mit **OK** bestätigen.
- ▶ Anweisungen auf Display befolgen.

DE



Warnung!

- Verletzungen durch Restmengen der Entkalkerlösung im Wassertank.
- ▶ Wassertank vollständig entleeren, bevor er zum Spülen erneut befüllt wird.

GB



FR

Nach ca. 20 Minuten ist der Entkalkungsvorgang abgeschlossen.

NL

Spülen

Aus hygienischen Gründen nach längerem Nichtgebrauch zunächst eine Gerätespülung durchführen.

- ▶ Taste  auf Display auswählen.
- ▶ Mit   zu **Spülen** wechseln und mit **OK** bestätigen.
- ▶ Anweisungen auf Display befolgen.

ES

IT

Reinigen



Warnung!

- Verletzungsgefahr durch Stromschlag.
- ▶ Vor jeder Reinigung Netzstecker ziehen.



Achtung!

- Beschädigung des Geräts durch unsachgemäße Reinigung.
- ▶ Gerät nicht in Wasser tauchen.
 - ▶ Gerät nicht unter fließendem Wasser reinigen.
 - ▶ Gerät nicht in der Spülmaschine reinigen.

- ▶ Netzstecker ziehen und Gerät abkühlen lassen.
- ▶ Oberfläche mit fusselfreiem, weichem Tuch reinigen.
- ▶ Schwenkfilter aufschwenken und den Filtereinsatz entnehmen. Papierfilter mit verbrauchtem Kaffeepulver entsorgen.

- ▶ Wassertank, Filtereinsatz, Filterring und Goldfilter mit Spülwasser reinigen und abtrocknen.
- ▶ Glaskanne nach Gebrauch mit warmem Spülwasser reinigen und abtrocknen.



Achtung



Beschädigung der Thermokanne durch unsachgemäße Reinigung.

- ▶ Thermokanne nicht in Wasser tauchen.
- ▶ Thermokanne nicht in der Spülmaschine reinigen.
- ▶ Thermokanne innen ausspülen, außen mit feuchtem Tuch reinigen und abtrocknen.
- ▶ Deckel Bohnenbehälter und Schwenkfilter mit feuchtem Tuch reinigen und abtrocknen.

Glaskanne, Filtereinsatz, Filterring und Goldfilter können auch in der Spülmaschine gereinigt werden.

Pulverausgabe reinigen

Aus hygienischen Gründen die Pulverausgabe regelmäßig (Empfehlung: wöchentlich) reinigen.

- ▶ Taste  auf Display auswählen.
- ▶ Mit   zu **Pulverausgabe** wechseln und mit **OK** bestätigen.

Um herausfallende Pulverreste aufzufangen: Gefäß unter die Pulverausgabe stellen.

- ▶ Anweisungen auf Display befolgen.

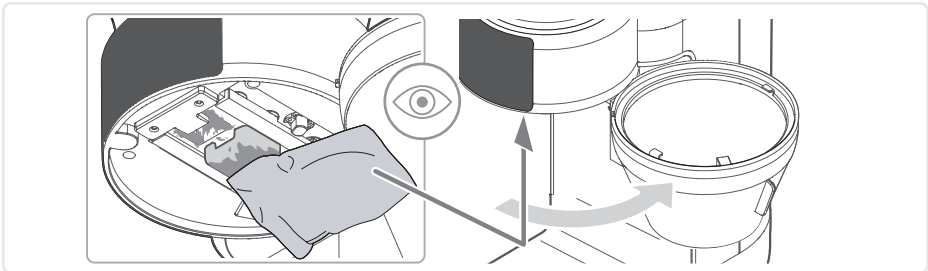

Mahlwerk und Bohnenbehälter reinigen

Mahlwerk und Bohnenbehälter regelmäßig reinigen (Empfehlung: bei sichtbarer Verschmutzung oder nach Wechseln der Bohnensorte).

- ▶ Netzstecker ziehen und Gerät abkühlen lassen.
- ▶ Kaffeebohnen aus Bohnenbehälter entfernen.
- ▶ Bohnenbehälter gegen den Uhrzeigersinn aufdrehen und abnehmen.
- ▶ Kaffeebohnenreste mit Handstaubsauger entfernen.
- ▶ Bügel am Mahlwerkeinsatz aufklappen und Mahlwerk gegen Uhrzeigersinn drehen und entnehmen.

Es lässt sich nur der Einsatz drehen, nicht das Mahlwerk selbst.

- ▶ Mahlwerkeinsatz und Mahlwerk mit Pinsel reinigen.
- ▶ Mahlwerkeinsatz einsetzen und im Uhrzeigersinn verriegeln.
- ▶ Bohnenbehälter feucht auswischen, Deckel im Spülwasser reinigen und beides gründlich abtrocknen.
- ▶ Bohnenbehälter aufsetzen (🔒) und nach links drehen (🔒).
- ▶ Gewünschten Mahlgrad beim nächsten Mahlvorgang einstellen.

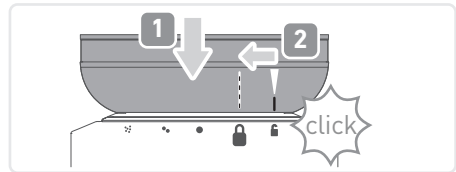

7 Transport / Lagerung

- ▶ Gerät reinigen und spülen, siehe Kapitel 6, *Reinigung & Pflege*.
- ▶ Gerät an trockenem Ort lagern.

8 FAQ



Warnung!

Verletzungsgefahr durch Betrieb eines defekten Geräts. Der Betrieb eines defekten Geräts kann zu Stromschlägen führen.

- ▶ Defektes Gerät niemals benutzen.
- ▶ Gerät nicht selbst reparieren, sondern den Severin Service kontaktieren.

Bevor Sie unseren Service kontaktieren, prüfen Sie anhand nachfolgender Tabelle, ob Sie das Problem selbst beheben können.

Frage / Problem	Lösung
Kaffee ist zu dünn.	Mahlgrad ist zu grob eingestellt. ▶ Mahlgrad feiner einstellen, siehe Kapitel 4, <i>Vor der ersten Inbetriebnahme / Mahlgrad.</i>
Aus dem Schwenkfilter kommt kein Kaffee.	Kaffeekanne steht nicht korrekt unter dem Auslauf. ▶ Kaffeekanne korrekt auf Heizplatte stellen und prüfen, ob Ventil des Auslaufs geöffnet wird.
Alle Displayanzeigen blinken.	Gerät ist defekt. ▶ Kundendienst kontaktieren.

Anzeige	Problem / Lösung
	Wassermangel ▶ Wasserbehälter füllen und Taste drücken.
	Gerät muss entkalkt werden. ▶ Gerät entkalken, siehe Seite 13, <i>Reinigung & Pflege Entkalken.</i>
	Gerät wird entkalkt. ▶ Anweisungen auf dem Display folgen.

DE

GB

FR

NL

ES

IT

DE

GB

FR

NL

ES

IT

Anzeige**Problem / Lösung**

Bohnenbehälter nicht korrekt aufgesetzt.

- ▶ Netzstecker ziehen und Bohnenbehälter korrekt montieren, siehe Kapitel 6, *Reinigung & Pflege* | *Mahlwerk reinigen*.



Gerät defekt.

- ▶ Kundendienst kontaktieren. Dazu QR-Code scannen.

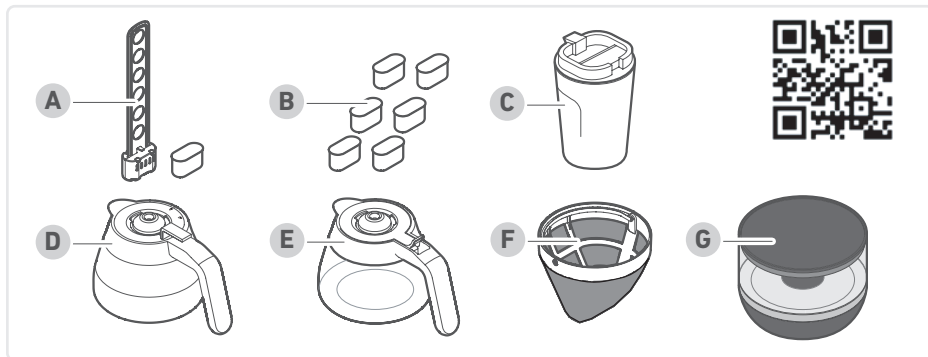
9 Zubehör

- A** Wasserfilter-Halterung mit Wasserfilterpatrone (Art.-Nr. 5562.000)
- B** Wasserfilter-Patronen, 6 Stück (Art.-Nr. 5557.000)
- C** Thermobecher „To-Go“ (Art.-Nr. 5555.000)
- D** Thermokanne (Edelstahl Art.-Nr. 5554.000 / Dark-Inox Art.-Nr. 5571.000)

- E** Glaskanne (Edelstahl Art.-Nr. 5553.000 / Dark-Inox Art.-Nr. 5556.000)
- F** Goldton-Filter (Art.-Nr. 5561.000)
- G** Ersatz-Bohnenbehälter für flexiblen Bohnenwechsel
(Edelstahl Art.-Nr. 5572.000 / Dark-Inox Art.-Nr. 5573.000)

DE

GB

FR

NL

ES

IT

10 Entsorgung



Geräte, die mit diesem Symbol gekennzeichnet sind, müssen getrennt vom Hausmüll entsorgt werden. Diese Geräte enthalten wertvolle Rohstoffe, die wiederverwertet werden können. Eine ordnungsgemäße Entsorgung schützt die Umwelt und die Gesundheit Ihrer Mitmenschen. Ihre Gemeindeverwaltung bzw. Ihr Fachhändler gibt Auskunft über die ordnungsgemäße Entsorgung.

11 Technische Daten

Artikelnummern	KA 4852, KA 4853, KA 4854, KA 4855
Leistung	1.280 – 1.520 W
Kapazität Wassertank	2 l
Kapazität Bohnenbehälter	235 g
Maße	46 x 38,2 x 17 cm
Nettogewicht	5,6 kg

Contents

	1 About this manual.....	21
	2 Scope of supply.....	22
DE	3 Display and control panel.....	23
GB	4 Before the first use.....	24
	Unpacking.....	24
FR	Cleaning.....	24
	Installation.....	24
NL	Settings.....	24
	Reset language.....	26
ES	5 Preparing coffee.....	29
IT	6 Cleaning and care.....	30
	Descaling.....	30
	Cleaning.....	31
	7 Transport/Storage.....	33
	8 FAQ.....	34
	9 Accessories.....	35
	10 Disposal.....	36
	11 Technical Data.....	36

1 About this manual

General information

These instructions are an integral part of the appliance.

- ▶ Read them carefully before setting up, installing and using the appliance and keep them for future reference.
- ▶ Pass them on to any subsequent owner or user of the product.

The appliance must only be used by persons familiar with the safety instructions.

Relevant documents

- Quick start guide
- Safety manual (Safety)
- Warranty declaration (Warranty)

Warning notices



Signal word

Type, source and consequences of the hazard

- ▶ Measures to avoid the hazard.

Signal word	Description
Danger	Imminently hazardous situation which, if not avoided, will result in death or serious injury.
Warning	Potentially hazardous situation which, if not avoided, could result in death or serious injury.
Caution	Potentially hazardous situation which, if not avoided, could result in minor injury.
Attention	Potentially hazardous situation which, if not avoided, can result in property damage.

DE

GB

FR

NL

ES

IT

DE

GB

FR

NL

ES

IT

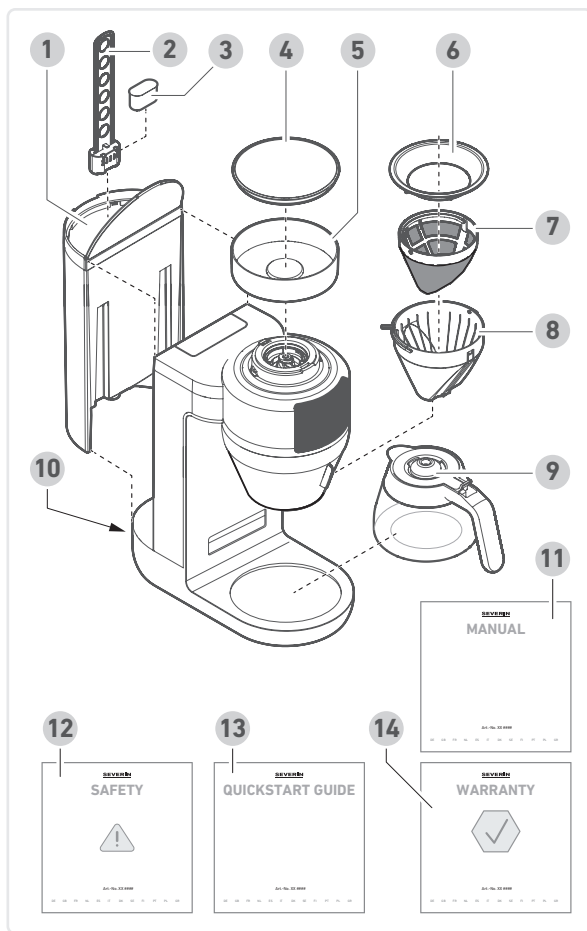

2 Scope of supply

- 1 Water tank
- 2 Water filter holder
- 3 Water filter cartridge
- 4 Bean container lid
- 5 Bean container
- 6 Filter ring
- 7 Gold tone filter
- 8 Filter insert
- 9 Jug
- 10 On/off switch
- 11 User manual
- 12 Safety instructions
- 13 Quick start guide
- 14 Warranty declaration



www.severin.com

3 Display and control panel

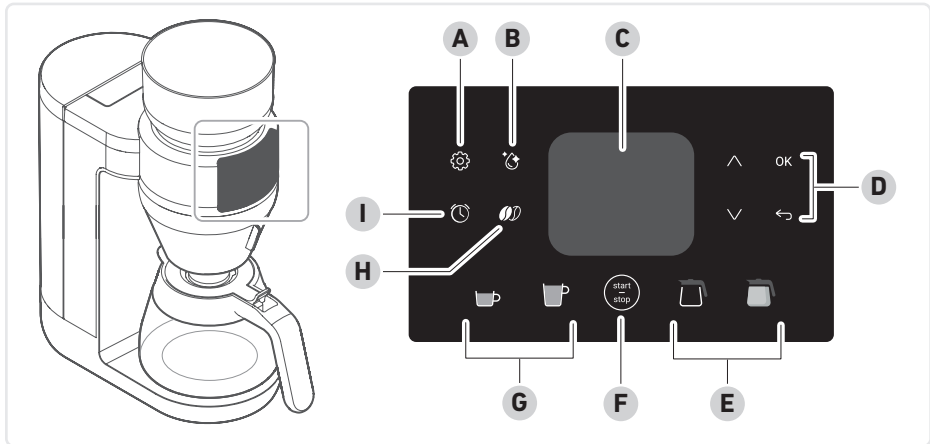

A Settings: Beans/Powder, Signal Tones, Water filter, Water hardness, Time, Instructions, Language, Expert, Keep warm, Reset

B Cleaning: Rinsing, descaling, powder dispensing

C Display

D Navigation: Use to select the various setting options, to confirm, to return to the previous menu item or to leave the menu

E Jug type: Glass jug or thermal jug (depending on the type)

F start - stop: Use this button to start and stop coffee dispensing or to activate the machine when in standby mode

G Cup size: Small cup: 100 - 150 ml, large cup: 175 - 350 ml in 25 ml increments

H Coffee strength

I Timer

DE

GB

FR

NL

ES

IT

4 Before the first use

Unpacking

- ▶ Remove all parts from the packaging.
- ▶ Remove all packaging material, protective film and stickers.
 - ! **Never remove the rating labels; they must always remain on the appliance.**
- ▶ Check the scope of delivery for completeness and damage.

Cleaning

- ▶ Clean all accessories, as described in Chapter 6 Cleaning and care.
- ▶ Perform rinsing three times, see page 31, *Rinsing*.

Installation

- ▶ Place the appliance on a dry, waterproof and heat-resistant surface.
- ▶ Do not place the appliance on marble or wooden surfaces without protection (risk of coffee/ descaling stains).
- ▶ Keep the appliance away from hot surfaces (e.g. hobs).
- ▶ Insert the power plug into an earthed power outlet.
- ▶ Use the switch on the bottom rear of the appliance to switch it on.

Settings

Before using the appliance for the first time or after resetting to factory defaults, the display provides an introduction to the appliance functions and selectable symbols. Follow the instructions on the display.

You can also change the settings as follows:

General settings

Signal Tones





- ▶ Select  on the display.
- ▶ Use   to switch to **Signal Tones** and press  to confirm.
- ▶ Follow the instructions on the display, confirm with  and press  to return to the main menu.

Water filter

The appliance can be used with and without a water filter.

When using the appliance without a water filter, adjust the water hardness setting, *Water hardness* see page 25, *Water hardness*.



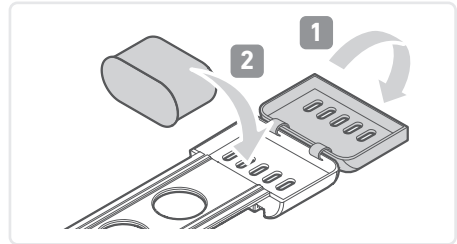

Change the water filter every 2 months or after approx. 50 litres of coffee.

- ▶ Fit the filter cartridge into the holder.
- ▶ Put the water filter holder into the empty water tank.
- ▶ Pour water into the water tank and wait at least 10 minutes before use.
- ▶ Select  on the display.
- ▶ Use   to switch to **Water filter** and press **OK** to confirm.
- ▶ Follow the instructions on the display, confirm with **OK** and press  to return to the main menu.



Water hardness

The water hardness should only be adjusted if no water filter is used.

- ▶ Select  on the display.
- ▶ Use   to switch to **Water hardness** and press **OK** to confirm.
- ▶ Follow the instructions on the display, confirm with **OK** and press  to return to the main menu.

Water hardness



soft







medium



hard



Time

- ▶ Select  on the display.
- ▶ Use   to switch to **Time** and press **OK** to confirm.
- ▶ Follow the instructions on the display, confirm with **OK** and press  to return to the main menu.

DE

GB

Instructions

- ▶ Select  on the display.
- ▶ Use   to switch to **Instructions** and press **OK** to confirm.
- ▶ Scan the QR code to access the instructions.

FR

NL

Language

- ▶ Select  on the display.
- ▶ Use   to switch to **Language** and press **OK** to confirm.
- ▶ Follow the instructions on the display, confirm with **OK** and press  to return to the main menu.





ES

IT

Resetting to factory defaults (default settings)

- ▶ Select  on the display.
- ▶ Use   to switch to **Reset** and press **OK** twice to confirm.

Wrong language selected?

- ▶ Press  to return to the main menu.
- ▶ Press , use   to navigate all the way down (grey bar at the bottom of the display) and press **OK** twice to confirm.

If this does not work, press **OK** repeatedly until the main menu is displayed. Then, press  and proceed as described above.

The appliance settings will be reset and the language can be selected again.

Standby mode



The appliance switches to standby after 5 minutes.

The display only shows the time and .

- ▶ Tap  or swivel open the filter to exit the standby mode.



Coffee preparation settings

Beans/powder

- ▶ Select  on the display.
- ▶ Navigate to **Beans/Powder** and press **OK** to confirm.
- ▶ Select **Beans** or **Powder**, confirm with **OK** and press  to return to the main menu.

Coffee strength

With coffee beans selected, you can choose between 5 levels of coffee strength after selecting the vessel:

- ▶ Press the button  to change the coffee strength and press  to start preparation.

Expert

Expert mode enables you to customise the coffee strength.





The default setting is 100%. The lower the setting, the milder the coffee.



Attention!

Filter overflow can cause damage to the appliance, surfaces and furniture.

- ▶ When >130% is set, no more than 6 cups may be dispensed when using a jug.

- ▶ Select  on the display.
- ▶ Use   to switch to **Expert** and press **OK** to confirm.
- ▶ Follow the instructions on the display, confirm with **OK** and press  to return to the main menu.

Grind



Attention!

Never change the grind level when the grinder is inactive as this can damage the appliance.

- ▶ The grind level may only be changed when the grinder is active.

The grind level can be continuously adjusted.

- ▶ With the grinder active, align the mark on the bean container with the desired grind setting.

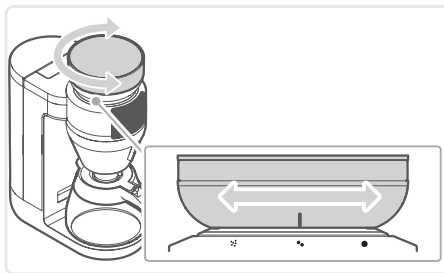



Timer

Before using the "Timer" function, make sure the time is set correctly.





With the alarm clock function activated, the preset amount of coffee is dispensed at the specified time.

Right before brewing, ensure the appliance is assembled correctly, coffee beans or powder and water are filled in sufficient quantities and a suitable vessel is placed under the spout.

- ▶ Select  on the display.
- ▶ Follow the instructions on the display, confirm with **OK** and press  to return to the main menu.

The alarm clock function must be reactivated before it can be used again. The settings are retained.

Keep warm

The keep warm function with the glass jug starts automatically after the brewing process. The time is factory preset to 30 minutes. Press   to change the time once (15-60 minutes). To permanently change the keep warm time, select  on the display. Use   to switch to **Keep warm** and press **OK** to confirm.

Follow the instructions on the display, confirm with **OK** and press  to return to the main menu.

You can activate the keep warm function from the main menu by pressing and holding .

DE

GB

FR

NL

ES

IT

5 Preparing coffee







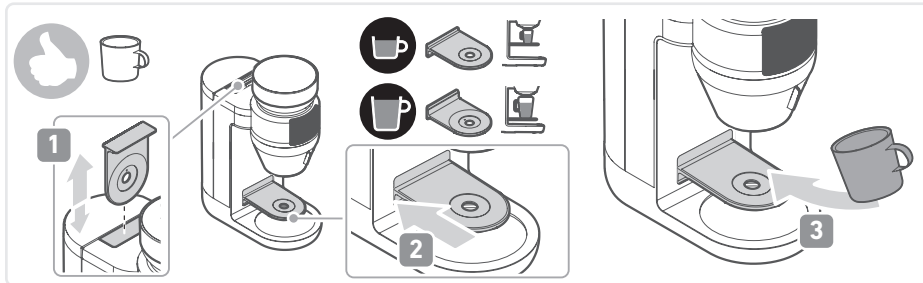
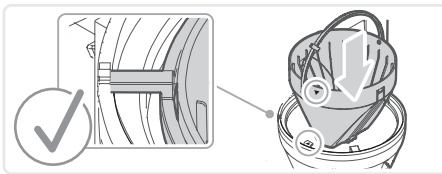

Warning!

Risk of scalding.

▶ Do not keep any body parts under the spout while the appliance is in operation.

- ▶ Pour no more than 2000 ml of cold, clear tap water into the water tank.
- ▶ Fit the filter insert.
- ▶ Insert the gold tone filter or disposable filter.
- ▶ Put on the filter ring.
- ▶ Depending on the selected preparation method, fill beans into the bean container or coffee powder into the coffee filter.
- ▶ Place the vessel of choice under the spout.



- ▶ Select the vessel on the display:    .
- ▶ Adjust the quantity and coffee strength.
- ▶ Press  to start the brewing process.
- ▶ Press the button  again to cancel the brewing process.

DE

GB

FR

NL

ES

IT

6 Cleaning and care

Descaling

DE

The appliance must be descaled depending on the water hardness and frequency of use. Any warranty claim will be null and void if the appliance malfunctions due to insufficient descaling.

GB

The indicator  lights up red on the display when the appliance needs to be descaled.

FR

The descaling process takes about 20 minutes.

NL

Descaling requires 70 ml of vinegar essence and 930 ml of water.

You can also use 1 litre of descaling agent instead.

ES



Caution!

Avoid emptying descaling agents into enamelled or other acid-sensitive sinks. This can damage the sink surface.

- ▶ Ensure the sink can withstand the descaling agent used.
- ▶ Dispose of the descaling agent properly.

IT





Warning!

During descaling, vinegar fumes are produced. These fumes can cause damage to your health if inhaled.

- ▶ Ensure adequate ventilation during descaling, and do not inhale the vinegar fumes.

Starting the descaling process

- ▶ Select the button  on display.
- ▶ Use   to switch to **Descaling** and press **OK** to confirm.
- ▶ Follow the instructions on the display.



Warning!

- Residual quantities of descaling solution in the water tank can cause injury.
- ▶ Empty the water tank completely before refilling it for rinsing.

The descaling process takes approx. 20 minutes to complete.

Rinsing

For hygiene reasons, rinse the appliance thoroughly after prolonged storage.

- ▶ Select the button  on display.
- ▶ Use   to switch to **Rinse** and press **OK** to confirm.
- ▶ Follow the instructions on the display.

Cleaning



Warning!

- Risk of injury from electric shock.
- ▶ Always pull out the power plug before attempting any cleaning.



Attention!

- Improper cleaning may damage the appliance.
- ▶ Do not immerse the appliance in water.
 - ▶ Do not clean the appliance under running water.
 - ▶ Do not clean the appliance in a dishwasher.

- ▶ Pull out the power plug and allow the appliance to cool down.
- ▶ Use a soft, lint-free cloth to clean the surface.
- ▶ Swivel open the swivel filter and remove the filter insert. Dispose of the paper filter with the used coffee grounds.
- ▶ Clean the water tank, filter insert, filter ring and gold tone filter with rinsing water and dry.
- ▶ After use, clean the glass jug with warm rinsing water and dry it.



Attention

The thermal jug may be damaged due to improper cleaning.

- ▶ Do not immerse the thermal jug in water.
- ▶ Do not clean the thermal jug in a dishwasher.

DE

GB

- ▶ Rinse the inside of the thermal jug, wipe the outside with a damp cloth and dry.
- ▶ Wipe the bean container lid and swivel filter with a damp cloth and dry them.

FR



Glass jug, filter insert, filter ring and gold tone filter can also be cleaned in the dishwasher.

NL

Cleaning the powder dispenser

For hygienic reasons, clean the powder dispenser regularly (recommendation: weekly).

ES

- ▶ Select the button  on display.
- ▶ Use   to switch to **Powder dispensing** and press **OK** to confirm.

IT

Place a container under the powder dispenser to catch any powder residue that falls out.

- ▶ Follow the instructions on the display.

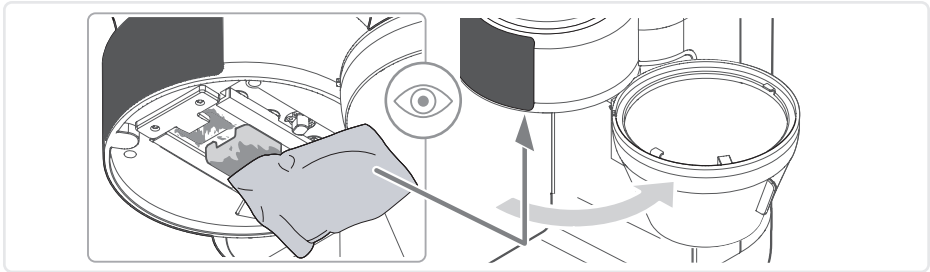

Cleaning the grinder and bean container

Clean the grinder and bean container regularly (it is recommended to do this when soiling is visible or after changing beans).

- ▶ Pull out the power plug and allow the appliance to cool down.
- ▶ Remove coffee beans from the bean container.
- ▶ Turn the bean container counter-clockwise and remove it.
- ▶ Remove coffee bean residues with a hand-held vacuum cleaner.
- ▶ Unfold the handle on the grinder insert, turn the grinder counter-clockwise and remove it.

You can only turn the insert, not the grinder itself.

- ▶ Clean the grinder insert and grinder with a brush.
- ▶ Insert the grinder insert and lock it by turning it clockwise.
- ▶ Wipe the bean container with a damp cloth, clean the lid in rinsing water and dry them thoroughly.
- ▶ Replace the bean container (🔒) and turn it to the left (🔒).
- ▶ Select the desired grind level before grinding coffee beans.

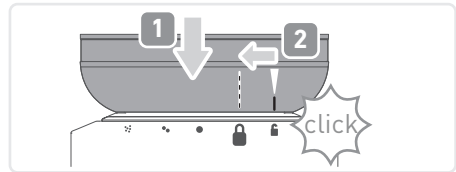

7 Transport/Storage

- ▶ Clean and rinse the appliance, as described in chapter 6, *Cleaning and care*.
- ▶ Store the appliance in a dry place.

8 FAQ



Warning!

Risk of injury from operating a faulty appliance. Operating a faulty appliance can lead to electric shock.

- ▶ Never use a faulty appliance.
- ▶ Never attempt to repair the appliance yourself, but contact Severin Service.

DE

GB





FR

NL

ES

IT

Before contacting our customer service, check the table below to see if you can rectify the problem yourself.

Question / problem	Solution
The coffee is too weak.	The grind setting is too coarse. ▶ Set a finer grind, as described in chapter 4, <i>Before the first use/ Grind</i> .
No coffee comes out of the swivel filter.	The glass jug is not properly placed underneath the outlet. ▶ Place the coffee pot correctly on the heating plate and check whether the outlet valve is opened.
All display indicators are flashing.	The appliance is defective. ▶ Contact customer service.
Display	Problem / Remedy
	Not enough water. ▶ Refill the water tank and press the  button.
	The appliance must be descaled. ▶ Descale the appliance, see page 30, <i>Cleaning and care / Descaling</i> .
	The appliance undergoes descaling. ▶ Follow the instructions on the display.

Display

Problem / Remedy



The bean container is fitted incorrectly.

- ▶ Pull out the power plug and install the bean container correctly, as described in chapter 6, *Cleaning and care / Cleaning the grinder*.



The appliance is defective.

- ▶ Contact customer service. To do this, scan the QR code.

9 Accessories

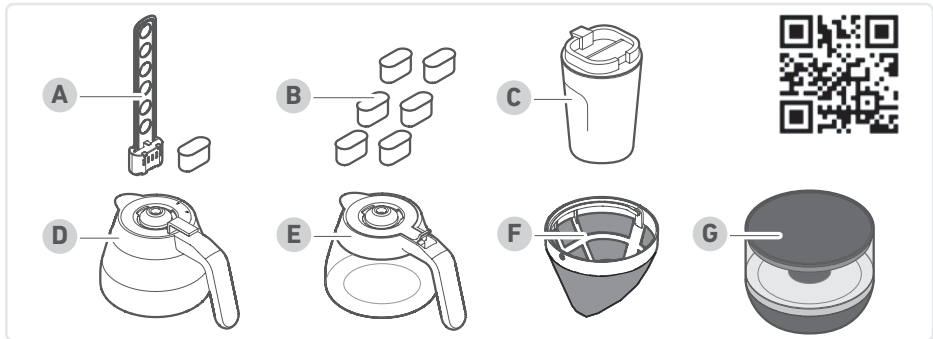

- A** Water filter holder with water filter cartridge (item no. 5562.000)
- B** Water filter cartridges, 6 pieces (item no. 5557.000)
- C** Thermal mug "To Go" (item no. 5555.000)
- D** Thermal jug (stainless steel item no. 5554.000 / Dark Inox item no. TK 5571.000)
- E** Glass jug (stainless steel item no. 5553.000 / Dark Inox item no. GK 5556.000)
- F** Gold tone filter (item no. 5561.000)
- G** Additional bean container for flexible bean changing (Stainless steel item no. ZB 5572.000 / Dark-Inox item no. ZB 5573.000)

DE

GB

FR

NL

ES

IT

10 Disposal



Appliances marked with this symbol must be disposed of separately from household waste. These appliances contain valuable raw materials that can be recycled. Proper disposal of these items protects the environment and public health. Your local authority or retailer can provide detailed information on proper disposal.

DE

GB

FR

NL

ES

IT

11 Technical Data

Item numbers	KA 4852, KA 4853, KA 4854, KA 4855
Power	1,280 – 1,520 W
Water tank capacity	2 l
Bean container capacity	235 g
Dimensions	46 x 38.2 x 17 cm
Net weight	5.6 kg

Contenu

1	À propos de ces instructions	38
2	Contenu de l'emballage	39
3	Affichage et panneau de commande	40
4	Avant la première utilisation	41
	Déballage	41
	Nettoyage	41
	Installation	41
	Paramètres	41
	Réinitialiser la langue	43
5	Préparation du café	46
6	Nettoyage et entretien	47
	Détartrage	47
	Nettoyage	48
7	Transport / rangement	50
8	FAQ	51
9	Accessoire	52
10	Mise au rebut	53
11	Caractéristiques techniques	53

FR

GB

FR

NL

ES

IT

1 À propos de ces instructions

Remarques générales

Ces instructions font partie intégrante de l'appareil.

- ▶ Lisez-les attentivement et conservez-les avant la mise en place, l'installation et la mise en service de l'appareil.
- ▶ Remettez ces instructions à tout utilisateur ultérieur.

L'appareil doit être utilisé exclusivement par des personnes familiarisées avec les instructions de sécurité.

Documents joints

- Guide de démarrage rapide
- Manuel de sécurité (Safety)
- Déclaration de garantie (Warranty)

Représentation des avertissements



Mot de signalisation

Type, source et conséquence du danger

- ▶ Mesures à prendre pour éviter le danger.

Mot de signalisation	Signification
Danger	Danger imminent entraînant la mort ou des blessures graves s'il n'est pas évité.
Avertissement	Danger potentiellement imminent qui, s'il n'est pas évité, peut entraîner la mort ou des blessures graves.
Attention	Danger potentiellement imminent qui, s'il n'est pas évité, peut entraîner des blessures légères.
Remarque	Danger potentiellement imminent qui, s'il n'est pas évité, peut entraîner des dommages matériels.

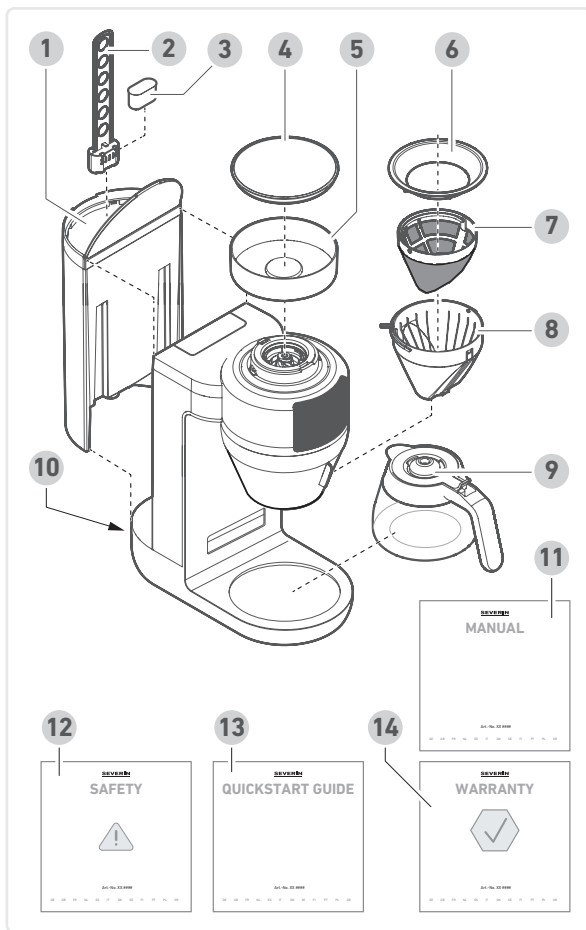

2 Contenu de l'emballage

- 1 Réservoir d'eau
- 2 Support pour filtre à eau
- 3 Cartouche de filtre à eau
- 4 Couvercle du réservoir à grains
- 5 Réservoir à grains
- 6 Anneau filtre
- 7 Filtre permanent
- 8 Support filtre
- 9 Verseau
- 10 Commutateur marche/arrêt
- 11 Manuel
- 12 Consignes de sécurité
- 13 Guide de démarrage rapide
- 14 Déclaration de garantie

DE

GB

FR

NL

ES

IT



www.severin.com

3 Affichage et panneau de commande

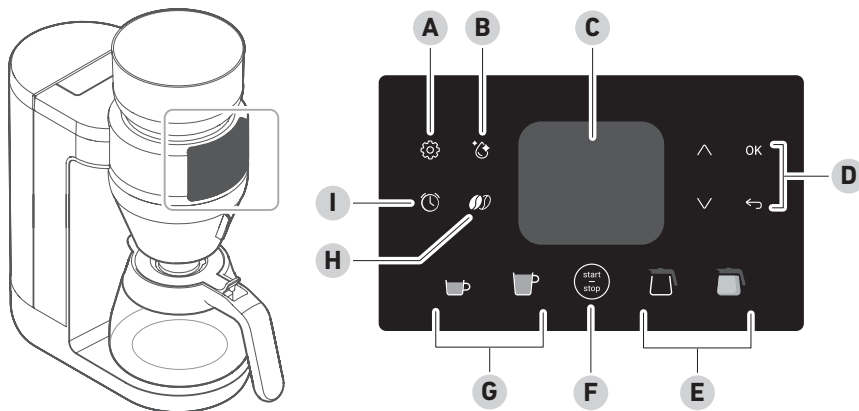

A Paramètres : Café grain ou moulu, signal sonore, filtre à eau, dureté de l'eau, heure, instructions, langue, expert, maintenir au chaud, réinitialiser

B Nettoyage : Rincer, détartrage, sortie de café moulu

C Affichage

D Navigation : ▲ ▼ pour sélectionner les différentes options de réglage, **OK** pour confirmer, ↵ revenir à l'option de menu précédente ou quitter le menu

E Type de verseuse : Verseuse en verre ou verseuse isotherme (selon la variante)

F start - stop : pour démarrer et arrêter la sortie de café, pour l'activer en mode veille

G Taille de la tasse : Petite tasse : 100 - 150 ml, grande tasse : 175 -350 ml par paliers de 25 ml

H Intensité du café

I Réveil

4 Avant la première utilisation

Déballage

- ▶ Retirez toutes les pièces de l'emballage.
- ▶ Retirez complètement le matériel d'emballage, les films de protection et les autocollants.
! Ne retirez pas les plaques signalétiques, elles doivent toujours rester sur l'appareil.
- ▶ Inspectez l'étendue de la livraison pour vérifier qu'il ne manque rien et qu'il n'y a aucune défaut.

Nettoyage

- ▶ Nettoyer tous les accessoires, voir Chapitre 6 Nettoyage et entretien.
- ▶ Effectuer trois cycles de rinçage, voir voir page 48, *Rincer*.

Installation

- ▶ Placez l'appareil sur une surface sèche, résistante à l'eau et à la chaleur.
- ▶ Ne placez pas l'appareil directement sur le marbre ou le bois (risque de taches de café/détartrant).
- ▶ Tenez l'appareil à l'écart des surfaces chaudes (par ex. plaques de cuisson).
- ▶ Branchez la fiche secteur sur une prise de terre.
- ▶ Allumez l'appareil à l'aide de l'interrupteur situé en bas à l'arrière de celui-ci.

Paramètres

Avant la première mise en service ou après la réinitialisation aux paramètres d'usine, une introduction aux fonctions de l'appareil et aux symboles pouvant être sélectionnés s'affiche à l'écran. Pour ce faire, suivez les instructions à l'écran.

Les paramètres peuvent également être modifiés comme suit :

Paramètres généraux

Signal sonore

- ▶ Sélectionnez l'option  sur l'écran.
- ▶ Passez au **signal sonore** en appuyant sur   et confirmez en appuyant sur **OK**.
- ▶ Suivez les instructions à l'écran, confirmez en appuyant sur **OK** et revenez au menu principal en appuyant sur .

DE

GB

FR

NL

ES





IT

Filtere à eau

L'appareil peut être utilisé avec ou sans filtre à eau.

En cas de fonctionnement sans filtre à eau, réglez la dureté de l'eau, *Dureté de l'eau* voir page 42, *Dureté de l'eau*.

Remplacez le filtre à eau tous les 2 mois ou après une quantité de café d'environ 50 l.

- ▶ Insérez la cartouche du filtre dans le support.
- ▶ Insérez le support pour filtre à eau dans le réservoir d'eau vide.
- ▶ Remplissez le réservoir d'eau avec de l'eau et attendez au moins 10 minutes avant de l'utiliser.
- ▶ Sélectionnez l'option  sur l'écran.
- ▶ Passez au **filtre à eau** en appuyant sur   et confirmez en appuyant sur **OK**.
- ▶ Suivez les instructions à l'écran, confirmez en appuyant sur **OK** et revenez au menu principal en appuyant sur .

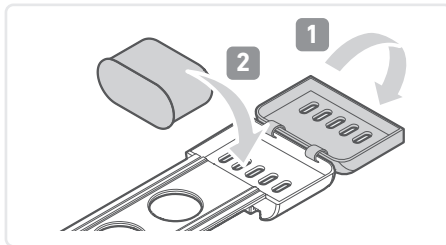

Dureté de l'eau

Réglez la dureté de l'eau uniquement si aucun filtre à eau n'est utilisé.

- ▶ Sélectionnez l'option  sur l'écran.
- ▶ Passez à la **dureté de l'eau** en appuyant sur   et confirmez en appuyant sur **OK**.
- ▶ Suivez les instructions à l'écran, confirmez en appuyant sur **OK** et revenez au menu principal en appuyant sur .

Dureté de l'eau



doux



moyen





dur

Heure

- ▶ Sélectionnez l'option  sur l'écran.
- ▶ Passez à **l'heure** en appuyant sur   et confirmez en appuyant sur **OK**.
- ▶ Suivez les instructions à l'écran, confirmez en appuyant sur **OK** et revenez au menu principal en appuyant sur .

Instructions

- ▶ Sélectionnez l'option  sur l'écran.
- ▶ Passez aux **instructions** en appuyant sur   et confirmez en appuyant sur **OK**.
- ▶ Scannez le code QR et accédez aux instructions.





Langue

- ▶ Sélectionnez l'option  sur l'écran.
- ▶ Passez à **la langue** en appuyant sur   et confirmez en appuyant sur **OK**.
- ▶ Suivez les instructions à l'écran, confirmez en appuyant sur **OK** et revenez au menu principal en appuyant sur .

Réinitialisation aux paramètres d'usine (paramètres par défaut)

- ▶ Sélectionnez l'option  sur l'écran.
- ▶ Passez à la **réinitialisation** en appuyant sur   et confirmez deux fois en appuyant sur **OK**.

Mauvaise langue sélectionnée ? :

- ▶ Revenez au menu principal avec .
- ▶ Appuyez sur , naviguez jusqu'en bas (barre grise sur l'écran tout en bas) en appuyant sur   et confirmez deux fois en appuyant sur **OK**.

Si cette solution ne fonctionne pas, appuyez plusieurs fois sur **OK** jusqu'à ce que le menu principal s'affiche. Puis appuyez sur  et procédez comme indiqué ci-dessus.

Les paramètres de l'appareil sont réinitialisés et vous pouvez à nouveau sélectionner la langue.

Mode veille

Après 5 minutes, l'appareil passe en mode veille.

Seuls l'heure et  sont visibles sur l'écran.

► Pour quitter le mode veille, appuyez sur  ou faites pivoter le filtre vers le haut.

Paramètres de préparation du café

Café grain ou moulu



► Sélectionnez l'option  sur l'écran.

► Accédez à l'option **Café grain ou moulu** et confirmez en appuyant sur **OK**.

► Sélectionnez **Café grain** ou **moulu**, confirmez en appuyant sur **OK** et revenez au menu principal en appuyant sur .

Intensité du café

En cas d'utilisation de café en grains, l'intensité du café peut être réglée sur 5 niveaux après sélection du récipient :

► Modifiez l'intensité du café en appuyant sur la touche  et commencez la préparation avec .

Expert

En mode Expert, l'intensité du café peut être réglée de manière encore plus personnalisée. Le réglage par défaut est de 100 %. Plus le réglage est faible, plus le café est doux.



Remarque !

Dommages causés à l'appareil, aux surfaces et aux meubles en cas de débordement du filtre.

► Avec un réglage > 130 %, le nombre de tasses ne doit pas dépasser 6 lors de la préparation avec une verseuse.

► Sélectionnez l'option  sur l'écran.

► Passez à **Expert** en appuyant sur   et confirmez en appuyant sur **OK**.

► Suivez les instructions à l'écran, confirmez en appuyant sur **OK** et revenez au menu principal en appuyant sur .

Degré de mouture



Remarque !

Une modification du degré de mouture lorsque le broyeur est inactif peut endommager l'appareil.

- ▶ Modifiez le degré de mouture uniquement lorsque le broyeur est actif.

Le degré de mouture peut être réglé en continu.

- ▶ Tournez le repère sur le réservoir à grains jusqu'au degré de mouture souhaité pendant que le broyeur est actif.

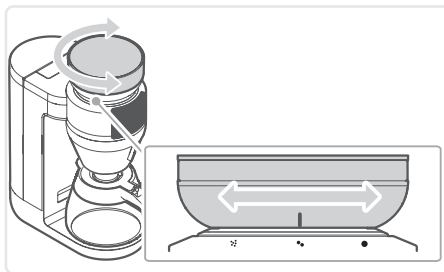

Réveil

Pour utiliser la fonction « réveil », l'heure doit être réglée correctement.

Lorsque la fonction de réveil est activée, la quantité de café réglée est distribuée à l'heure indiquée. Au moment de la préparation, l'appareil doit être correctement assemblé, le café grain ou moulu et l'eau doit être rempli en quantité suffisante et un récipient approprié doit être placé sous le bec verseur.

- ▶ Sélectionnez l'option sur l'écran.
- ▶ Suivez les instructions à l'écran, confirmez en appuyant sur **OK** et revenez au menu principal en appuyant sur .

Vous devez réactiver la fonction réveil si vous souhaitez la réutiliser. Les paramètres sont conservés.

Garder au chaud

La fonction Maintenir au chaud avec verseuse en verre démarre automatiquement après le processus d'infusion. La durée est fixée à 30 minutes départ usine. Pour modifier la durée (15 à 60 minutes) appuyez sur . Pour effectuer une modification permanente du temps de maintien au chaud, sélectionner l'écran . En appuyant sur , passez à **Garder au chaud** et confirmez en appuyant sur **OK**. Suivez les instructions à l'écran, confirmez en appuyant sur **OK** et revenez au menu principal en appuyant sur .

Vous pouvez également activer la fonction Maintenir au chaud dans le menu principal en appuyant sur et en le maintenant enfoncé.

DE

GB

FR

NL

ES

IT

5 Préparation du café



Avertissement !

Risque de brûlure.

► Ne maintenez aucune partie de votre corps sous le bec verseur pendant que l'appareil est en fonctionnement.

- Remplissez le réservoir d'eau avec au maximum 2 000 ml d'eau de robinet froide.
- Insérez la cartouche filtrante.
- Insérez le filtre permanent ou le filtre jetable.
- Placez l'anneau filtre.
- Selon le mode de préparation choisi, versez le café grain dans le récipient à grains ou le café moulu dans le filtre à café.
- Placez le récipient souhaité sous le bec verseur.

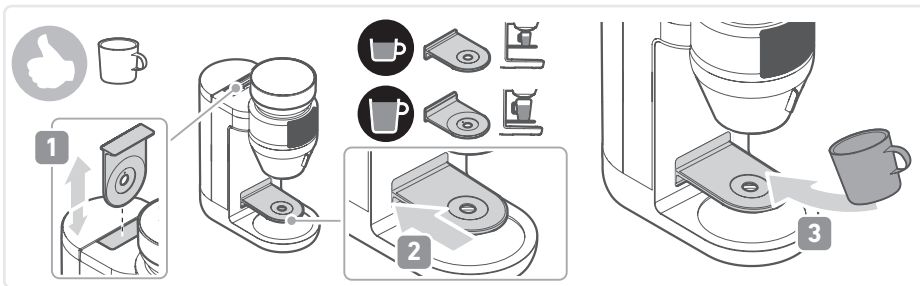
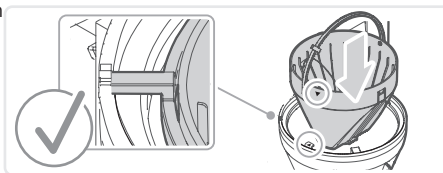

- Sélectionnez le récipient sur l'écran :
- Réglez la quantité et éventuellement l'intensité du café.
- Démarrez le processus d'infusion en appuyant sur
- Appuyez à nouveau sur la touche

6 Nettoyage et entretien

Détartrage

L'appareil doit être détartré en fonction de la teneur en calcaire de l'eau et de la fréquence d'utilisation.

Aucune réclamation en matière de garantie ne sera prise en compte si l'appareil ne fonctionne pas correctement en raison d'un détartrage insuffisant.

Sur l'écran,  s'allume en rouge lorsque l'appareil doit être détartré.

Le processus de détartrage dure environ 20 minutes.

70 ml d'essence de vinaigre et 930 ml d'eau sont nécessaires pour le détartrage.

Vous pouvez également utiliser 1 l de détartrant.



Attention !

Ne versez pas de détartrant dans les éviers émaillés ou autres éviers sensibles aux acides. Ceux-ci peuvent être endommagés.

- ▶ Assurez-vous que l'évier est conçu pour les produits de détartrage utilisés.
- ▶ Éliminez le détartrant de manière appropriée.



Avertissement !

De la vapeur de vinaigre se forme pendant le détartrage. Celle-ci est nocive si elle est inhalée.

- ▶ Veillez à une aération suffisante pendant le détartrage et n'inhaliez pas la vapeur de vinaigre.

DE

GB



FR

NL

ES

IT

Démarrage du processus de détartrage

- ▶ Sélectionnez la touche  sur l'écran.
- ▶ Passez au **détartrage** en appuyant sur   et confirmez en appuyant sur **OK**.
- ▶ Suivez les instructions à l'écran.

DE



Avertissement !

Blessures causées par des quantités résiduelles de la solution de détartrage dans le réservoir d'eau.

- ▶ Videz complètement le réservoir d'eau avant de le remplir à nouveau pour le rincer.

GB

FR

NL



ES

IT

Après environ 20 minutes, le détartrage est terminé.

Rincer

Pour des raisons d'hygiène, procédez d'abord à un rinçage de l'appareil après une longue période de non-utilisation.

- ▶ Sélectionnez la touche  sur l'écran.
- ▶ Passez au **Rincer** en appuyant sur   et confirmez en appuyant sur **OK**.
- ▶ Suivez les instructions à l'écran.

Nettoyage



Avertissement !

Risque de blessure par électrocution.

- ▶ Débranchez la fiche secteur avant tout nettoyage.



Attention !

Endommagement de l'appareil en cas de nettoyage inapproprié.

- ▶ Ne plongez jamais l'appareil dans l'eau.
 - ▶ Ne nettoyez pas l'appareil sous l'eau courante.
 - ▶ Ne nettoyez pas l'appareil dans le lave-vaisselle.
- ▶ Débranchez l'appareil et laissez-le refroidir.
 - ▶ Nettoyez la surface avec un chiffon doux et non pelucheux.
 - ▶ Faites pivoter le porte-filtre et retirez la cartouche filtrante. Jetez le filtre en papier contenant le café moulu usagé.

- ▶ Nettoyez et séchez le réservoir d'eau, la cartouche filtrante, l'anneau filtre et le filtre permanent or à l'eau savonneuse.
- ▶ Après usage, nettoyez la verseuse en verre à l'eau savonneuse chaude et séchez-la.



Attention



Endommagement de la verseuse isotherme en cas de nettoyage inapproprié.

- ▶ Ne plongez jamais la verseuse isotherme dans l'eau.
 - ▶ Ne nettoyez pas la verseuse isotherme dans le lave-vaisselle.
- ▶ Rincez l'intérieur de la verseuse isotherme, nettoyez l'extérieur avec un chiffon humide et séchez-la.
 - ▶ Nettoyez le couvercle du réservoir à grains et le porte-filtre pivotant avec un chiffon humide et séchez-les.

La verseuse en verre, la cartouche filtrante, l'anneau filtre et le filtre permanent or peuvent également être nettoyés au lave-vaisselle.

Nettoyez la sortie de café moulu

Pour des raisons d'hygiène, nettoyez régulièrement la sortie de café moulu (recommandation : par semaine).

- ▶ Sélectionnez la touche  sur l'écran.
- ▶ Passez à la **sortie du café moulu** en appuyant sur   et confirmez en appuyant sur **OK**.

Pour recueillir les résidus de café moulu qui tombent : Placez le récipient sous la sortie de café moulu.

- ▶ Suivez les instructions à l'écran.

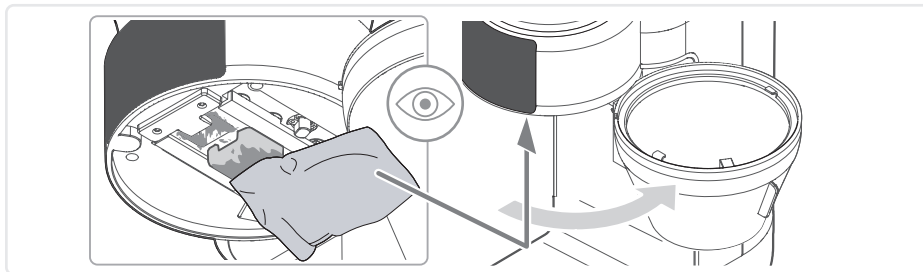

DE

GB

FR

NL

ES

IT

Nettoyez le broyeur et le réservoir à grains

Nettoyez régulièrement le broyeur et le réservoir à grains (recommandation : en cas de salissure visible ou après avoir changé le type de grains).

- ▶ Débranchez l'appareil et laissez-le refroidir.
- ▶ Retirez les grains de café du récipient à grains.
- ▶ Dévissez et retirez le récipient à grains dans le sens inverse des aiguilles d'une montre.
- ▶ Enlevez les résidus de grains de café à l'aide d'un aspirateur à main.
- ▶ Ouvrez l'étrier sur l'insert du broyeur et tournez le broyeur dans le sens inverse des aiguilles d'une montre pour le retirer.

Seul l'insert peut être tourné, pas le broyeur lui-même.

- ▶ Nettoyez l'insert du broyeur et le broyeur avec un pinceau.
- ▶ Insérez l'insert du broyeur et verrouillez-le dans le sens des aiguilles d'une montre.
- ▶ Essayez le récipient à graines humide, nettoyez le couvercle à l'eau savonneuse et séchez soigneusement les deux.
- ▶ Placez le récipient à graines (🔒) et tournez-le vers la gauche (🔒).
- ▶ Réglez le degré de mouture souhaité lors du processus de broyage suivant.

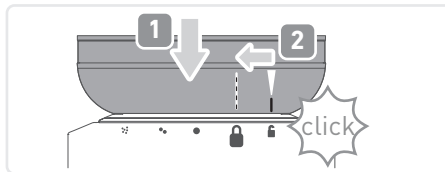

7 Transport / rangement

- ▶ Nettoyez et rincez l'appareil, voir chapitre 6, *Nettoyage et entretien*.
- ▶ Rangez l'appareil dans un endroit sec.

8 FAQ



Avertissement !

Risque de blessure en cas d'utilisation d'un appareil défectueux. L'utilisation d'un appareil défectueux peut entraîner une électrocution.

- ▶ N'utilisez jamais un appareil défectueux.
- ▶ Ne réparez pas l'appareil vous-même, mais contactez le service après-vente Severin.

Avant de contacter notre service après-vente, vérifiez à l'aide du tableau ci-dessous si vous pouvez résoudre le problème vous-même.

Question / problème	Solution
Le café est trop fin.	Le degré de mouture est réglé de manière trop grossière. ▶ Régler le degré de mouture plus finement, voir chapitre 4, <i>Avant la première utilisation / degré de mouture.</i>
Le café ne s'écoule pas du porte-filtre.	La verseuse est mal placée sous l'écoulement. ▶ Placez correctement la verseuse sur la plaque chauffante et vérifiez si la vanne d'écoulement est ouverte.
Les indications à l'écran clignotent.	L'appareil est défectueux. ▶ Contactez le service clientèle.

Affichage	Problème / Solution
	Le niveau d'eau est trop bas ▶ Remplissez le réservoir d'eau et appuyez sur la touche
	L'appareil doit être détartré. ▶ Détartrer l'appareil, voir voir page 47, <i>Nettoyage et entretien / Détartrer.</i>
	L'appareil est en cours de détartrage. ▶ Suivez les instructions à l'écran.

DE

GB

FR

NL

ES

IT

Affichage

Problème / Solution



Le récipient à graines n'est pas correctement placé.

- Retirer la fiche secteur et monter correctement le récipient à grains, voir chapitre 6, *Nettoyage et entretien* | *Nettoyer le broyeur*.



Appareil défectueux.

- Contactez le service clientèle. Pour ce faire, scannez le code QR.

DE

GB

FR

NL

ES

IT

9 Accessoire

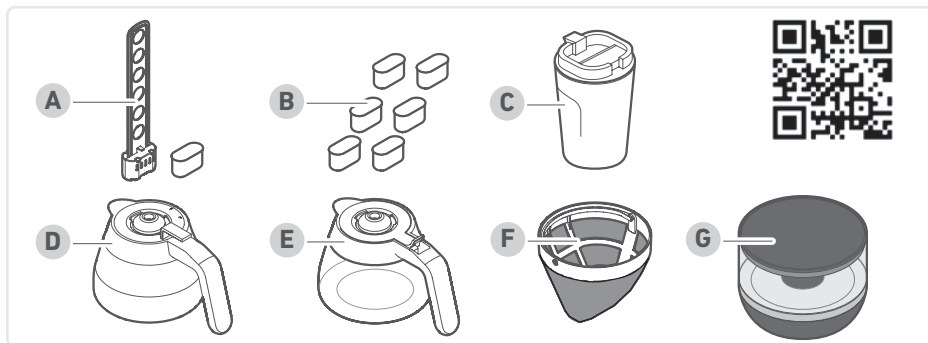

A Support pour filtre à eau avec cartouche de filtre à eau (réf. 5562.000)

B Cartouches de filtre à eau, 6 pièces (réf. 5557.000)

C Gobelet isotherme « To-Go » (réf. 5555.000)

D Verseuse isotherme (en acier inoxydable, réf. 5554.000 / en inox foncé, réf. TK 5571.000)

- E** Verseuse en verre (en acier inoxydable, réf. 5553.000/ en inox foncé, réf. GK 5556.000)
- F** Filtre de teinte dorée (réf. 5561.000)
- G** Réservoir à grains pour un échange flexible des grains
(en acier inoxydable, réf. ZB 5572.000 / en inox foncé ref. ZB 5573.000)

DE

GB

FR

NL

ES

IT

10 Mise au rebut



Les appareils sur lesquels figurent ce symbole ne doivent pas être jetés avec les ordures ménagères. Ces appareils contiennent des matières premières précieuses, susceptibles d'être recyclées. Une mise au rebut conforme permet de contribuer à la protection de l'environnement et de la santé d'autrui. Votre mairie ou le magasin auprès duquel vous avez acquis l'appareil peuvent vous donner des informations à ce sujet.

11 Caractéristiques techniques

Références	KA 4852, KA 4853, KA 4854, KA 4855
Puissance	1 280 – 1 520 W
Capacité du réservoir d'eau	2 l
Capacité du réservoir à graines	235 g
Dimensions	46 x 38,2 x 17 cm
Poids net	5,6 kg

Inhoud

	1	Over deze handleiding.....	55
	2	De levering omvat.....	56
DE	3	Display en bedieningspaneel.....	57
GB	4	Vóór het eerste gebruik.....	58
		Uitpakken.....	58
FR		Onderhoud.....	58
		Opstellen.....	58
NL		Instellingen.....	58
		Taal resetten.....	60
ES	5	Koffiebereiding.....	63
IT	6	Onderhoud en onderhoud.....	64
		Ontkalking.....	64
		Reinigen.....	65
	7	Transport/opslag.....	67
	8	FAQ.....	68
	9	Accessoires.....	69
	10	Verwijdering.....	70
	11	Technische gegevens.....	70

1 Over deze handleiding

Algemene informatie

Deze gebruiksaanwijzing maakt deel uit van het apparaat.

- ▶ Lees ze zorgvuldig door voordat u het apparaat opstelt, installeert en in gebruik neemt, en bewaar ze zodat u ze later kunt raadplegen.
- ▶ Geef ze door aan iedere volgende gebruiker.

Het apparaat mag alleen worden gebruikt door personen, die bekend zijn met de veiligheidsaanwijzingen.

Andere documenten die van toepassing zijn

- Snelstartgids
- Veiligheidshandleiding (Safety)
- Garantieverklaring (Warranty)

Weergave van waarschuwingsberichten



Signaalwoord

Type, bron en gevolg van het gevaar

- ▶ Maatregelen om het gevaar te vermijden.

Signaalwoord	Betekenis
Gevaar	Onmiddellijk gevaarlijke situatie die, als ze niet vermeden wordt, de dood of ernstige verwondingen tot gevolg zal hebben.
Waarschuwing	Mogelijk dreigend gevaar dat de dood of ernstig letsel tot gevolg kan hebben als het gevaar niet wordt afgewend.
Voorzichtig	Potentieel dreigend gevaar dat tot licht letsel kan leiden als het niet wordt vermeden.
Opmerking	Mogelijk dreigend gevaar dat materiële schade tot gevolg kan hebben als het gevaar niet wordt vermeden.

DE

GB

FR

NL

ES

IT

DE

GB

FR

NL

ES

IT

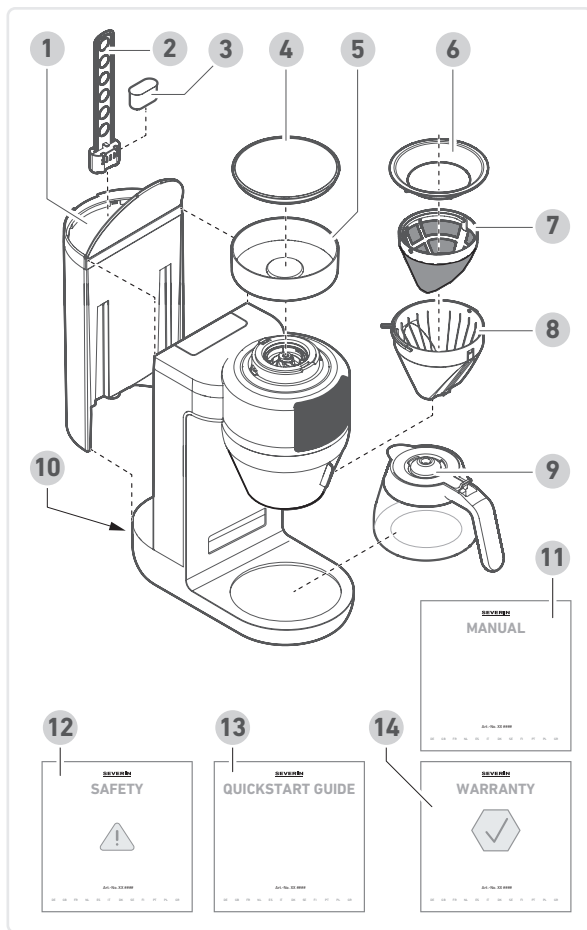

2 De levering omvat

- 1 Watertank
- 2 Waterfilterhouder
- 3 Waterkanpatroon
- 4 Deksel bonenreservoir
- 5 Bonenreservoir
- 6 Filterring
- 7 Goudkleurige filter
- 8 Filterinzet
- 9 Kan
- 10 Aan-/uitschakelaar
- 11 Handleiding
- 12 Veiligheidsinstructies
- 13 Snelstartgids
- 14 Garantieverklaring



www.severin.com

3 Display en bedieningspaneel

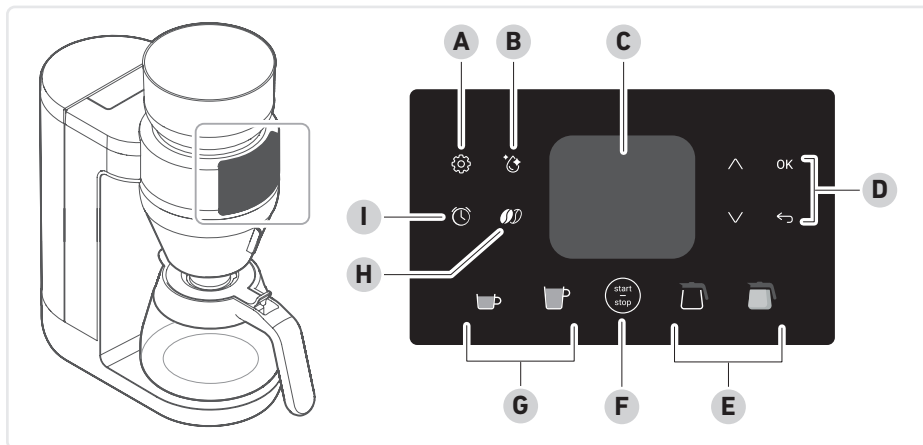

- A Instellingen:** Bonen / Koffiepoeder, signaaltonen, waterfilter, waterhardheid, tijd, handleiding, taal, expert, warmhouden, resetten
- B Onderhoud:** Spoeling, ontkalking, poederuitvoer
- C Displayweergave**
- D Navigatie:** om de verschillende instellingsopties te selecteren, **OK** te bevestigen, terug te keren naar het vorige menu-item of het menu te verlaten
- E Type kan:** Glazen kan of thermoskan (afhankelijk van de variant)
- F start - stop:** voor het starten en stoppen van de koffie-uitgifte, voor het activeren in de standby-modus
- G Kopgrootte:** Mok klein: 100 - 150 ml, kop groot: 175 - 350 ml in stappen van 25 ml
- H Koffiesterkte**
- I Wekker**

DE

GB

FR

NL

ES

IT

4 Vóór het eerste gebruik

Uitpakken

- ▶ Haal alle onderdelen uit de verpakking.
- ▶ Verwijder al het verpakkingsmateriaal, beschermfolie en stickers.
 - ! **Verwijder de typeplaatjes niet, deze moeten op het apparaat blijven zitten.**
- ▶ Controleer de leveringsomvang op volledigheid en gebreken.

Onderhoud

- ▶ Alle accessoires reinigen, zie Hoofdstuk 6Onderhoud en onderhoud.
- ▶ Voer drie spoelcycli uit, zie pagina 65, *Spoeling*.

Opstellen

- ▶ Plaats het apparaat op een droge, waterdichte en hittebestendige ondergrond.
- ▶ Plaats het apparaat niet direct op marmer of hout (gevaar voor koffie-/ontkalkingsvlekken).
- ▶ Houd het apparaat uit de buurt van hete oppervlakken (bijv. kookplaten).
- ▶ Steek de stekker in een geaard stopcontact.
- ▶ Schakel het apparaat in met de schakelaar aan de onderkant van het apparaat.





Instellingen

Vóór de eerste ingebruikname of na het resetten naar de fabrieksinstellingen vindt op het display een inleiding tot de apparaatfuncties en selecteerbare symbolen plaats. Volg hiervoor de instructies op het display.

Als alternatief kunnen de instellingen als volgt worden gewijzigd:

Instellingen algemeen

Signaaltonen





- ▶ Selecteer op het display .
- ▶ Schakel met   naar **signaaltonen** en bevestig met **OK**.
- ▶ Volg de instructies op het display, bevestig met **OK** en keer terug met  naar het hoofdmenu.

Waterfilter

Het apparaat kan met en zonder waterfilter worden gebruikt.

Bij gebruik zonder waterfilter de instelling waterhardheid aanpassen, *Waterhardheid* zie pagina 59, *Waterhardheid*.

Vervang het waterfilter om de 2 maanden of na een hoeveelheid koffie van ongeveer 50 liter.

- ▶ Plaats de filterpatroon in de houder.
- ▶ Plaats de waterfilterhouder in een lege watertank.
- ▶ Vul de watertank met water en wacht minimaal 10 minuten voor gebruik.
- ▶ Selecteer op het display .
- ▶ Met   naar **waterfilter** wisselen en met  bevestigen.
- ▶ Volg de instructies op het display, bevestig met  en keer terug met  naar het hoofdmenu.

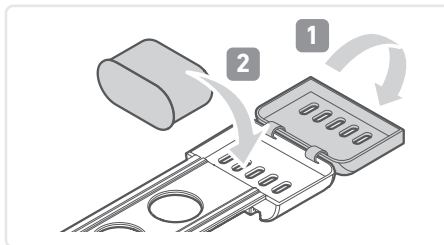

Waterhardheid

Stel de waterhardheid alleen in als er geen waterfilter wordt gebruikt.

- ▶ Selecteer op het display .
- ▶ Schakel met   over naar **waterhardheid** en bevestig met .
- ▶ Volg de instructies op het display, bevestig met  en keer terug met  naar het hoofdmenu.

Waterhardheid



zacht



gemiddeld



hard

DE

GB



FR

NL

ES

IT





Tijd

- ▶ Selecteer op het display .
- ▶ Met   naar **tijd** wisselen en met **OK** bevestigen.
- ▶ Volg de instructies op het display, bevestig met **OK** en keer terug met  naar het hoofdmenu.

Handleiding

- ▶ Selecteer op het display .
- ▶ Met   naar de **handleiding** gaan en met **OK** bevestigen.
- ▶ Scan de QR-code en raadpleeg de handleiding.





Taal

- ▶ Selecteer op het display .
- ▶ Met   naar **taal** wisselen en met **OK** bevestigen.
- ▶ Volg de instructies op het display, bevestig met **OK** en keer terug met  naar het hoofdmenu.

Resetten naar fabrieksinstellingen (standaardinstellingen)

- ▶ Selecteer op het display .
- ▶ Overschakelen met   naar **Resetten** en twee keer met **OK** bevestigen.

Verkeerde taal geselecteerd?:

- ▶ Met  terug naar het hoofdmenu.
- ▶  drukken, met   helemaal naar beneden navigeren (grijze balk in het display helemaal onderaan) en tweemaal met **OK** bevestigen.

Als deze oplossing niet werkt, druk dan **OK** herhaaldelijk totdat het hoofdmenu wordt weergegeven. Druk vervolgens op  en ga te werk zoals hierboven aangegeven.

De apparaatinstellingen worden gereset en de taal kan opnieuw worden geselecteerd.

DE

GB

FR

NL

ES

IT

Standby-modus



Na 5 minuten schakelt het apparaat over naar stand-by.

Op het display is alleen de tijd en  zichtbaar.

- ▶ Tik  of zwenk het filter open om de standby-modus te verlaten.

Instellingen koffiebereiding

Bonen/Koffiepoeder

- ▶ Selecteer op het display .
- ▶ Navigeer naar **Bonen / Koffiepoeder** en bevestig met **OK**.
- ▶ Kies **Bonen** of **Koffiepoeder**, bevestig met **OK** en keer terug met  naar het hoofdmenu.

Koffiesterkte

De koffiesterkte kan bij het gebruik van koffiebonen naar keuze in 5 stappen worden ingesteld:

- ▶ Druk op de knop  om de koffiesterkte te wijzigen en start met  de bereiding.

Expert

In de expertmodus kan de koffiesterkte nog individueeler worden ingesteld.





De fabrieksinstelling is 100%. Hoe lager de instelling is, hoe milder de koffie zal zijn.



Opmerking!

Schade aan het apparaat, oppervlakken en meubels door overlopen van het filter.

- ▶ Bij een instelling van >130% mag het aantal kopjes bij bereiding met kan maximaal 6 zijn.

- ▶ Selecteer op het display .
- ▶ Ga met   naar **Expert** en bevestig met **OK**.
- ▶ Volg de instructies op het display, bevestig met **OK** en keer terug met  naar het hoofdmenu.

DE

GB

FR

NL

ES

IT

Maalgraad



Opmerking!

Een verandering van de maalgraad bij inactieve molen kan leiden tot schade aan het apparaat.

- ▶ Maalgraad alleen bij actieve molen veranderen.

De maalgraad is traploos instelbaar.

- ▶ Draai de markering op het bonenreservoir op de gewenste maalgraad terwijl de molen actief is.

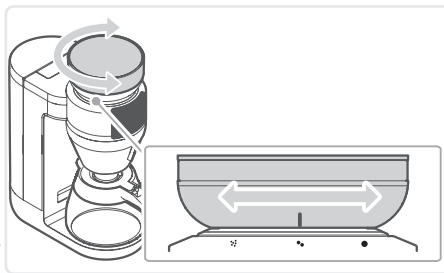

Wekker

Om de "wekker"-functie te gebruiken, moet de tijd correct zijn ingesteld.

Bij geactiveerde wekkerfunctie wordt op het aangegeven tijdstip koffie met ingestelde hoeveelheid afgegeven.

Op het moment van bereiding moet het apparaat correct zijn samengesteld, moeten koffiebonen of -poeder en water in voldoende hoeveelheid zijn gevuld en moet er een geschikte bakje onder de uitloop staan.

- ▶ Selecteer op het display

- ▶ Volg de instructies op het display, bevestig met **OK** en keer terug met naar het hoofdmenu.

Om de wekker opnieuw te gebruiken, moet de functie opnieuw worden geactiveerd. De instellingen blijven behouden.

Warmhouden

De warmhoudfunctie met glazen kan start automatisch na het zetproces. De duur is in de fabriek ingesteld op 30 minuten. Om de tijdsduur (15-60 minuten) eenmalig te veranderen drukt u op . Om de warmhoudtijdsduur voor altijd te veranderen selecteert u op het display. Wissel met naar **Warmhouden** en bevestigen met **OK**.

Volg de instructies op het display, bevestig met **OK** en keer terug met naar het hoofdmenu.

Als alternatief kunt u de warmhoudfunctie in het hoofdmenu openen door lang op te drukken.

5 Koffiebereiding



Waarschuwing!

Gevaar voor verbranding.

▶ Houd geen lichaamsdelen onder uitloop terwijl het apparaat in bedrijf is.

- ▶ Vul de watertank met maximaal 2000 ml koud leidingwater.
- ▶ Plaats het filterinzetstuk.
- ▶ Goudkleurige filters of wegwerpfilters plaatsen.
- ▶ Plaats de filterring.
- ▶ Giet bonen in bonencontainers of koffiepoeder in koffiefilters, afhankelijk van de gekozen bereidingswijze.
- ▶ Plaats het gewenste vat onder de uitloop.

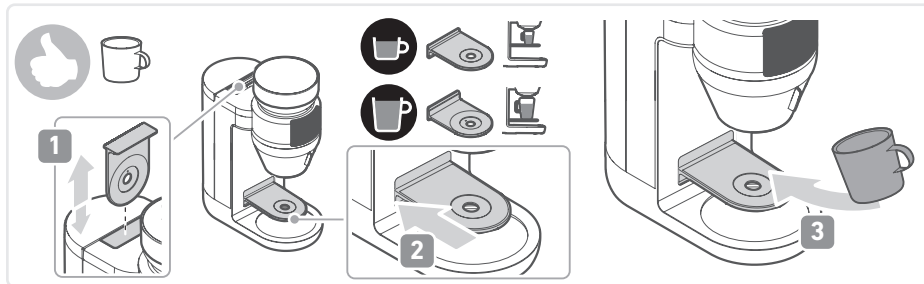
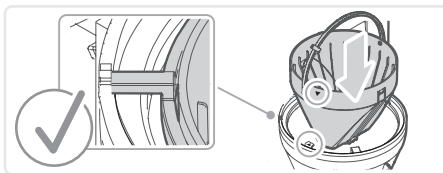

- ▶ Selecteer op het display vat:    .
- ▶ Stel hoeveelheid en eventueel koffiesterkte in.
- ▶ Zetproces met  starten.
- ▶ Druk nogmaals op de knop  om het zetproces af te breken.

DE

GB

FR

NL

ES

IT

6 Onderhoud en onderhoud

Ontkalking

DE

Het apparaat moet worden ontkalkt, afhankelijk van het kalkgehalte van het water en de gebruiksfrequentie.

GB

Bij apparaten, die omwille van onvoldoende ontkalking niet correct werken, vervalt de garantie. Op het display brandt  rood wanneer het apparaat moet worden ontkalkt.

FR

Het ontkalkingsproces duurt ongeveer 20 minuten.

NL

Voor het ontkalken zijn 70 ml azijnessentie en 930 ml water nodig.

Alternatief 1 l ontkalkingsmiddel.

ES



Voorzichtig!

Giet geen ontkalkingsmiddelen in geëmailleerde of andere zuurgevoelige afvoerbassins.

Deze kunnen schade oplopen.

- ▶ Zorg ervoor dat het afvoerbekken is ontworpen voor de gebruikte ontkalkingsmiddelen.
- ▶ Ontkalkingsmiddelen op de juiste manier afvoeren.

IT





Waarschuwing!

Tijdens het ontkalken ontstaat azijndamp. Dit is schadelijk voor de gezondheid als het wordt ingeademd.

- ▶ Zorg tijdens het ontkalken voor voldoende ventilatie en adem de azijndamp niet in.

Ontkalkingsproces starten

- ▶ Selecteer de knop  op display.
- ▶ Wissel met   naar **Ontkalking** en bevestig met **OK**.
- ▶ Instructies op display opvolgen.



Waarschuwing!

Verwondingen door resthoeveelheden van de ontkalkingsoplossing in de watertank.

- ▶ Leeg de watertank volledig voordat u het opnieuw vult voor het spoelen.

Na ongeveer 20 minuten is het ontkalkingsproces voltooid.

Spoeling

Om hygiënische redenen moet u het apparaat na een langere tijd niet-gebruik eerst doorspoelen.

- ▶ Selecteer de knop  op display.
- ▶ Wissel met   naar **Spoeling** en bevestig met **OK**.
- ▶ Instructies op display opvolgen.

Reinigen



Waarschuwing!

Gevaar voor letsel door elektrische schokken.

- ▶ Trek voor elke reiniging de stekker uit het stopcontact.



Let op!

Beschadiging van het apparaat door onjuiste reiniging.

- ▶ Dompel het apparaat niet onder in water.
 - ▶ Reinig het apparaat niet onder stromend water.
 - ▶ Reinig het apparaat niet in de vaatwasmachine.
- ▶ Trek de stekker uit het stopcontact en laat het apparaat afkoelen.
 - ▶ Reinig het oppervlak met een pluisvrije, zachte doek.
 - ▶ Draai het filter open en verwijder het filterelement. Gooi het papieren filter met het koffiedik weg.
 - ▶ Reinig en droog de watertank, het filterelement, de filterring en het goudfilter met afwaswater.
 - ▶ Reinig de glazen kan met warm afwaswater en droog het.

DE

GB

FR

NL

ES

IT



Let op

Beschadiging van de termoskan door onjuiste reiniging.

- ▶ Dompel de termoskan niet onder in water.
- ▶ Reinig de termoskan niet in de vaatwasmachine.

DE

GB

FR

NL

▶ Spoel de binnenkant van de termosfles af, maak de buitenkant schoon met een vochtige doek en droog hem af.

▶ Droog het deksel van de bonenreservoir en zwenkfilter met een vochtige doek en droog hem af.

Glazen kan, filterelement, filterring en goudfilter kunnen ook in de vaatwasser worden gereinigd.

ES

IT

Poederuitgifte reinigen

Om hygiënische redenen moet de poederuitgifte regelmatig (advies: wekelijks) worden gereinigd.

▶ Selecteer de knop  op display.

▶ Wissel met   naar **Poederuitvoer** en bevestigen met **OK**.

Om uitvallende poederresten op te vangen: Plaats het vat onder de poederuitgifte.

▶ Instructies op display opvolgen.

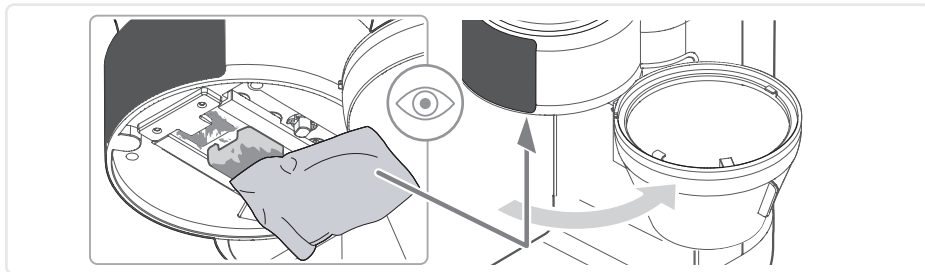

Molen en bonenreservoir reinigen

Molen en bonenreservoir regelmatig reinigen (advies: bij zichtbare vervuiling of na het vervangen van de bonensoort).

- ▶ Trek de stekker uit het stopcontact en laat het apparaat afkoelen.
- ▶ Verwijder de koffiebonen uit het bonenreservoir.
- ▶ Draai het bonenreservoir linksom open en verwijder het.
- ▶ Verwijder koffiebonenresten met een handstofzuiger.
- ▶ Klap de beugel op het inzetstuk van de molen open en draai de molen linksom en verwijder hem.

Alleen het inzetstuk kan worden gedraaid, niet de molen zelf.

- ▶ Reinig het molenzetstuk en de molen met een kwast.
- ▶ Molenzetstuk plaatsen en met de klok mee vergrendelen.
- ▶ Veeg het bonenreservoir vochtig schoon, reinig het deksel in afwaswater en droog beide grondig af.
- ▶ Bonencontainer plaatsen (🔒) en naar links draaien (🔒).
- ▶ Stel de gewenste maalgraad in bij het volgende maalproces.

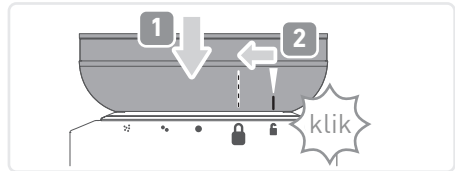

7 Transport/opslag

- ▶ Reinig en spoel het apparaat, zie hoofdstuk 6, *Onderhoud en onderhoud*.
- ▶ Bewaar het apparaat op een droge plaats.

8 FAQ



Waarschuwing!

Risico op letsel door het bedienen van een defect apparaat. Het bedienen van een defect apparaat kan leiden tot elektrische schokken.

- ▶ Gebruik nooit een defect apparaat.
- ▶ Repareer het apparaat niet zelf, maar neem contact op met Severin Service.

Voordat u contact opneemt met onze servicedienst, kunt u aan de hand van de volgende tabel controleren of u het probleem zelf kunt verhelpen.

Vraag/probleem	Oplossing
Koffie is te dun.	Maalgraad is te grof ingesteld. ▶ Maalgraad fijner instellen, zie hoofdstuk4, <i>Vóór het eerste gebruik / Maalgraad.</i>
Er komt geen koffie uit het zwenkfilter.	De koffiekkan staat niet correct onder de uitloop. ▶ Zet de koffiekkan correct op de verwarmingsplaat en controleer of het ventiel van de uitloop wordt geopend.
Alle displayindicatoren knipperen	Het apparaat is defect. ▶ Neem contact op met de klantenservice.

Weergave

Probleem/Oplossing



Water tekort.

- ▶ Vukl het waterreservoir, en druk op de toets .



Apparaat moet worden ontkalkt.

- ▶ Apparaat ontkalken, zie pagina 64, *Onderhoud en onderhoud / Ontkalking.*



Het apparaat wordt ontkalkt.

- ▶ Volg de instructies op het display.

Weergave

Probleem/Oplissing



Bonencontainer niet correct geplaatst.

- ▶ Trek de stekker uit het stopcontact en monteer het bonenreservoir correct, zie hoofdstuk 6, *Onderhoud en onderhoud / Molen reinigen*.



Apparaat defect.

- ▶ Neem contact op met de klantenservice. Scan hiervoor de QR-code.

9 Accessoires

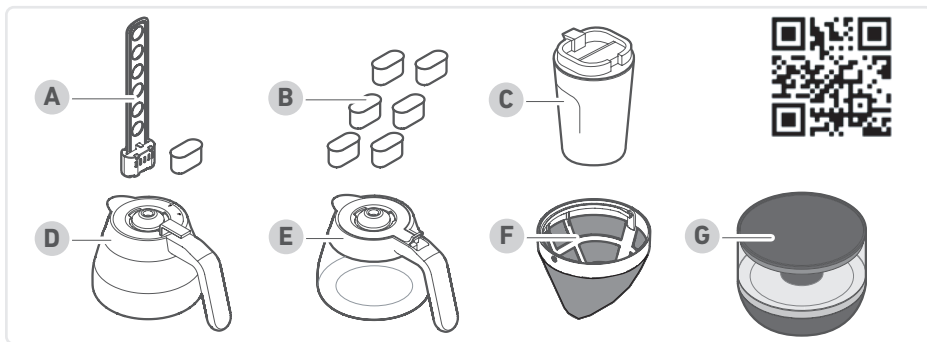

- A** Waterfilterhouder met waterfilterpatroon (art.nr. 5562.000)
- B** Waterfilterpatronen, 6 stuks (art.nr. 5557.000)
- C** Thermobeker "To-Go" (art.nr. 5555.000)
- D** Thermoskan (RVS art.nr. 5554.000 / Dark-Inox art.nr. TK 5571.000)
- E** Glazen kan (RVS art.nr. 5553.000 / Dark-Inox art.nr. GK 5556.000)
- F** Goudkleurige filter (art.nr. 5561.000)
- G** Bonenreservoir voor flexibele bonenvervanging (RVS art.nr. ZB 5572.000 / Dark-Inox art.nr. ZB 5573.000)

10 Verwijdering



Apparaten, die met dit symbool zijn gemarkeerd, moeten gescheiden van het huisvuil worden verwijderd. Deze apparaten bevatten waardevolle grondstoffen, die gerecycleerd kunnen worden. Een correcte verwijdering beschermt het milieu en de gezondheid van de mensen om u heen. De plaatselijke overheid resp. uw vakhandelaar geven meer informatie over het correct verwijderen.

DE

GB

FR

NL

ES

IT

11 Technische gegevens

Artikelnummer	KA 4852, KA 4853, KA 4854, KA 4855
Vermogen	1.280 – 1.520 W
Capaciteit watertank	2 l
Capaciteit bonencontainer	235 g
Afmetingen	46 x 38,2 x 17 cm
Netto gewicht	5,6 kg

Contenido

1	Acerca de estas instrucciones	72
2	Material	73
3	Indicadores y panel de control	74
4	Antes de la primera puesta en marcha	75
	Desembalaje	75
	Limpieza	75
	Instalación	75
	Ajustes	75
	Restablecer idioma	77
5	Preparación del café	80
6	Limpieza y cuidado	81
	Eliminar la cal	81
	Limpieza	82
7	Transporte/almacenamiento	84
8	FAQ	85
9	Accesorios	86
10	Eliminación	87
11	Especificaciones técnicas	87

DE

GB

FR

NL

ES

IT

1 Acerca de estas instrucciones

Indicaciones generales

Estas instrucciones son un componente más del aparato.

- ▶ Léelas atentamente antes de montar, instalar y poner en marcha el aparato y consérvelas para futuras consultas.
- ▶ Entréguelas a cualquier usuario posterior.

Solo deberán utilizar el aparato las personas que estén familiarizadas con las instrucciones de seguridad.

Otra documentación útil

- Guía de inicio rápido
- Manual de seguridad (Safety)
- Declaración de garantía (Warranty)

Presentación de los avisos de advertencia



Palabra de advertencia

Tipo, origen y consecuencias del peligro

- ▶ Medidas para evitar el peligro.

Palabra de advertencia	Significado
Peligro	Situación de peligro inminente que, si no se evita, provocará la muerte o lesiones graves.
Advertencia	Peligro potencialmente inminente que, si no se evita, puede provocar la muerte o lesiones graves.
Precaución	Peligro potencialmente inminente que puede provocar lesiones leves si no se evita.
Nota	Peligro potencialmente inminente que puede provocar daños materiales si no se evita.

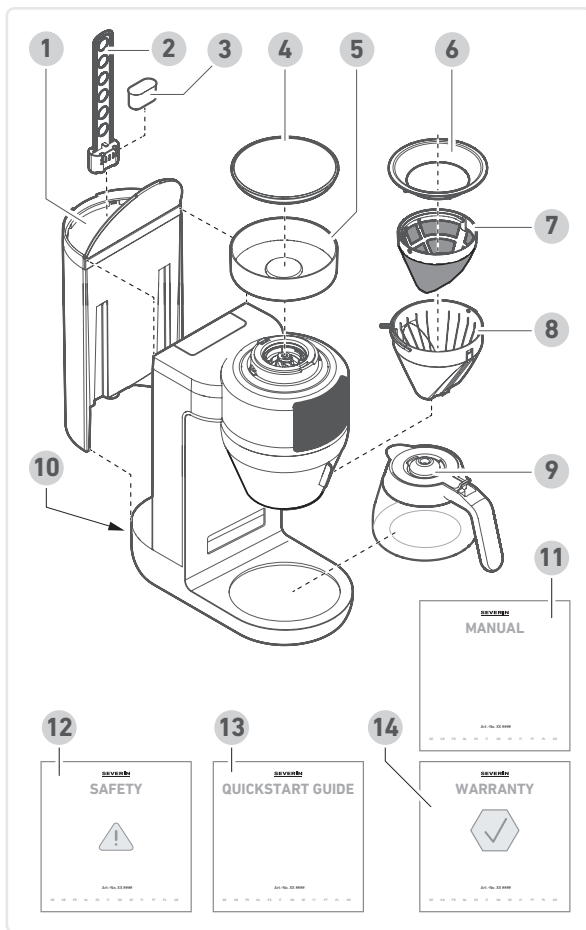

2 Material

- 1 Depósito del agua
- 2 Soporte para el filtro del agua
- 3 Cartucho del filtro de agua
- 4 Tapa del depósito para el grano
- 5 Depósito para el grano
- 6 Aro para el filtro
- 7 Filtro dorado
- 8 Conjunto del filtro
- 9 Jarra
- 10 Interruptor de encendido/apagado
- 11 Manual
- 12 Instrucciones de seguridad
- 13 Guía de inicio rápido
- 14 Declaración de garantía

DE

GB

FR

NL

ES

IT



www.severin.com

3 Indicadores y panel de control

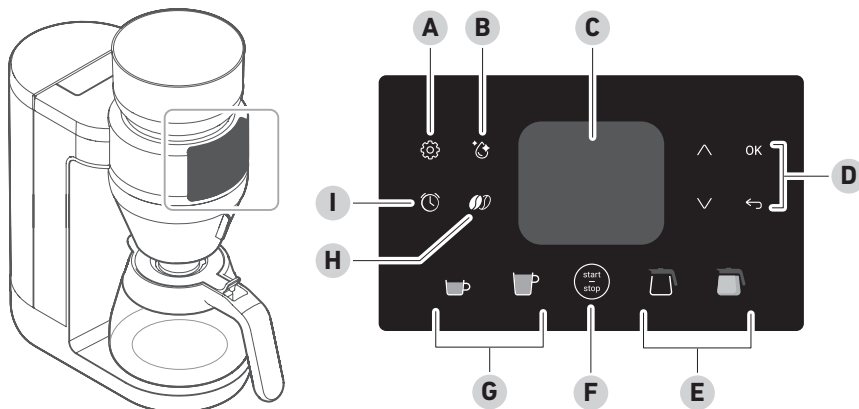

A Ajustes: Granos/ café molido, señales acústicas, filtro de agua, dureza del agua, hora, instrucciones, idioma, experto, mantener caliente, restablecer

B Limpieza Enjuague, descalcificación, dispensación de café molido

C Visualización de la pantalla

D Navegación: ▲ ▼ para seleccionar las diferentes opciones de configuración, **OK** para confirmar, ↶ ↷ para volver al elemento de menú anterior o salir del menú

E Tipo de jarra: Jarra de vidrio o jarra térmica (dependiendo de la versión)

F start (inicio) - stop (parada): para iniciar y detener la salida del café, para activar el modo en espera

G Tamaño de la taza; taza pequeña: 100 - 150 ml, taza grande: 175 - 350 ml en incrementos de 25 ml

H Intensidad del café

I Alarma

4 Antes de la primera puesta en marcha

Desembalaje

- ▶ Saque todas las piezas del embalaje.
- ▶ Retire todo el material de embalaje, la película protectora y los adhesivos.
 - ! **No retire las placas de características, éstas deben permanecer en el aparato.**
- ▶ Compruebe que el material incluido en el suministro esté completo y no tenga defectos.

Limpieza

- ▶ Limpie todos los accesorios, consulte Capítulo 6 Limpieza y cuidado.
- ▶ Realice tres ciclos de enjuagado, consulte la página 82, *Enjuague*.

Instalación

- ▶ Coloque el aparato sobre una superficie seca, resistente al agua y al calor .
- ▶ No coloque el aparato directamente sobre mármol o madera (riesgo de manchas de café/descalcificación).
- ▶ Mantenga el aparato alejado de superficies calientes (por ejemplo, placas de cocina).
- ▶ Inserte el enchufe de red en una toma con conexión a tierra.
- ▶ Encienda el aparato con el interruptor en la parte inferior trasera del mismo.





Ajustes

Antes de la primera puesta en marcha o después de restablecer la configuración de fábrica, se realiza en la pantalla una introducción a las funciones del aparato y a los símbolos seleccionables. Siga las instrucciones de la pantalla.

Los ajustes también pueden cambiarse del siguiente modo:

Ajustes generales

Señales acústicas

- ▶ Seleccione  en la pantalla.
- ▶ Cambien   a **señales acústicas** y confirme con **OK**.
- ▶ Siga las instrucciones de la pantalla, confirme con **OK** y vuelva con  al menú principal.

DE

GB

FR

NL

ES





IT

Filtro de agua

El aparato se puede utilizar con y sin filtro de agua.

Si se utiliza sin filtro de agua, ajuste la dureza del agua, *Dureza del agua* consulte la página 76, *Dureza del agua*.



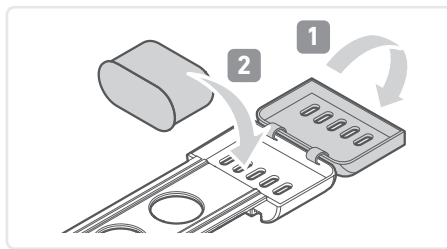

Cambie el filtro de agua cada 2 meses o después de una cantidad de café de aproximadamente 50 l.

- ▶ Coloque el cartucho del filtro en el soporte.
- ▶ Coloque el soporte del filtro de agua en el depósito de agua vacío.
- ▶ Llene el depósito de agua con agua y espere al menos 10 minutos antes de utilizar el aparato.
- ▶ Seleccione  en la pantalla.
- ▶ Con   cambie a **filtro de agua** y confirme con **OK**.
- ▶ Siga las instrucciones de la pantalla, confirme con **OK** y vuelva con  al menú principal.



Dureza del agua

Ajuste la dureza del agua solo si no se utiliza un filtro de agua.

- ▶ Seleccione  en la pantalla.
- ▶ Con   cambie a **dureza del agua** y confirme con **OK**.
- ▶ Siga las instrucciones de la pantalla, confirme con **OK** y vuelva con  al menú principal.

Dureza del agua



blanda



media





dura



Hora

- ▶ Seleccione  en la pantalla.
- ▶ Con   cambie a **hora** y confirme con **OK**.
- ▶ Siga las instrucciones de la pantalla, confirme con **OK** y vuelva con  al menú principal.

Instrucciones

- ▶ Seleccione  en la pantalla.
- ▶ Con   cambie a **instrucciones** y confirme con **OK**.
- ▶ Escanee el código QR y acceda a las instrucciones.





Idioma

- ▶ Seleccione  en la pantalla.
- ▶ Con   cambie a **idioma** y confirme con **OK**.
- ▶ Siga las instrucciones de la pantalla, confirme con **OK** y vuelva con  al menú principal.

Restablecer la configuración de fábrica (configuración predeterminada)

- ▶ Seleccione  en la pantalla.
- ▶ Con   cambie a **restablecer** y confirme dos veces con **OK**.

¿Idioma incorrecto seleccionado?:

- ▶ Vuelva con  al menú principal.
- ▶ Pulse , navegue con   hasta la parte inferior (barra gris en la parte inferior de la pantalla) y confirme dos veces con **OK**.

Si esta solución no funciona, siga pulsando **OK** hasta que aparezca el menú principal. A continuación, pulse  y proceda como se ha indicado anteriormente.

Los ajustes del aparato se restablecen y se puede volver a seleccionar el idioma.

Modo de espera

Pasados 5 minutos, el aparato pasa al modo en espera.

En la pantalla solo se pueden ver la hora y .

▶ Toque  o gire el filtro hacia arriba para salir del modo en espera.

Ajustes de la preparación del café

Granos/café molido

▶ Seleccione  en la pantalla.

▶ Navegue hasta **granos/café molido** y confirme con **OK**.

▶ Seleccione **granos** o **café molido**, confirme con **OK** y vuelva al menú principal con .

Intensidad del café

La intensidad del café se puede ajustar en 5 niveles cuando se utilizan granos de café, después de seleccionar el recipiente:

▶ Pulsando el botón  cambie la intensidad del café e inicie la preparación con .

Experto

En el modo experto, puede seleccionarse individualmente la intensidad del café.

El ajuste de fábrica es el 100 %. Cuanto menor valor se seleccione, más suave será el café.



¡Nota!

Daños en el aparato, superficies y muebles por desbordamiento del filtro.

▶ Con un ajuste de >130%, el número máximo de tazas para la preparación con jarra es de 6.

▶ Seleccione  en la pantalla.

▶ Con   cambie a **Experto** y confirme con **OK**.

▶ Siga las instrucciones de la pantalla, confirme con **OK** y vuelva con  al menú principal.

Grado de molido



¡Nota!

Un cambio en el grado de molido cuando el molinillo está inactivo puede provocar daños en el aparato.

- ▶ Cambie el grado de molido solo cuando el molinillo esté activo.

El grado de molido se puede ajustar de forma continua.

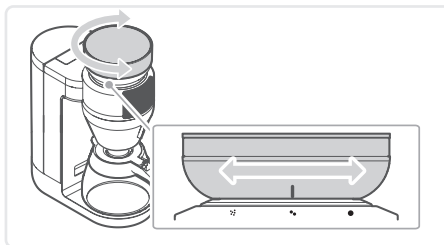

- ▶ Gire la marca en el recipiente de grano hasta el grado de molido deseado mientras el molinillo está activo.









Alarma

Para utilizar la función de «Alarma», la hora debe estar configurada correctamente.

Si la función de despertador está activada, se hará la cantidad de café seleccionada a la hora especificada. En el momento de la preparación, el aparato debe estar correctamente montado, deben haberse echado cantidad suficiente de granos de café o café molido y de agua y debe haber un recipiente adecuado colocado debajo de la boquilla de salida.

- ▶ Seleccione  en la pantalla.
 - ▶ Siga las instrucciones de la pantalla, confirme con **OK** y vuelva con  al menú principal.
- Para volver a utilizar el despertador, debe volver a activarse la función. Los ajustes se conservan.

Mantener caliente

La función de mantenimiento en caliente con jarra de vidrio se inicia automáticamente después del proceso de preparación. La duración está ajustada de fábrica en 30 minutos. Para cambiar una sola vez la duración (15 - 60 minutos), pulse  . Para cambiar permanentemente el tiempo de mantenimiento en caliente, seleccione  en la pantalla. Con   cambie a **mantener caliente** y confirme con **OK**. Siga las instrucciones de la pantalla, confirme con **OK** y vuelva con  al menú principal.

También puede iniciar la función de mantenimiento en caliente en el menú principal con una pulsación larga de .

DE

GB

FR

NL

ES

IT

5 Preparación del café



¡Advertencia!

Riesgo de escaldaduras.

- ▶ No mantenga ninguna parte del cuerpo debajo de la boquilla de salida mientras el aparato está en funcionamiento.

- ▶ Llene el depósito del agua con un máximo de 2000 ml de agua fría y del grifo.
- ▶ Coloque el conjunto del filtro.
- ▶ Coloque un filtro dorado o un filtro desechable.
- ▶ Coloque el anillo del filtro.
- ▶ Dependiendo del método de preparación elegido, eche los granos en el recipiente para grano o el café molido en el filtro para café.
- ▶ Coloque el recipiente deseado debajo de la boquilla de salida.

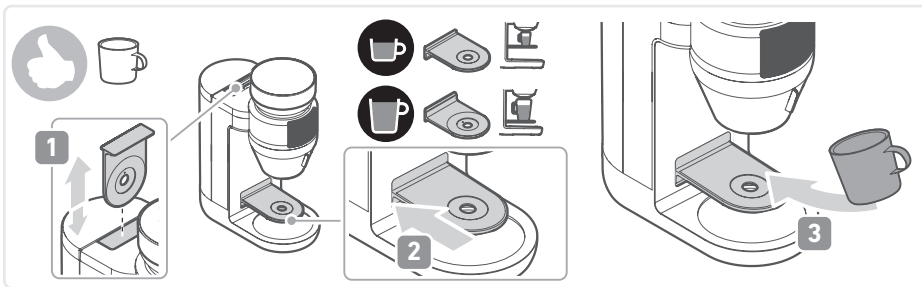
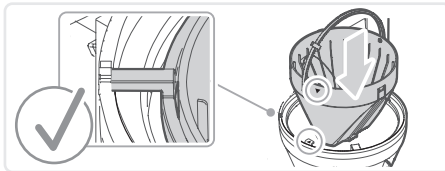

- ▶ Seleccione el recipiente en la pantalla:
- ▶ Ajuste la cantidad y, en su caso, la intensidad del café.
- ▶ Inicie el proceso de preparación con
- ▶ Pulse nuevamente el botón

6 Limpieza y cuidado

Eliminar la cal

El aparato debe descalcificarse en función del contenido de cal del agua y de la frecuencia de uso.

La garantía no se aplicará en caso de aparatos que no funcionen correctamente por falta de descalcificación.

En la pantalla se ilumina  en rojo cuando es necesario descalcificar el aparato.

El proceso de descalcificación dura unos 20 minutos.

Para la descalcificación se necesitan 70 ml de esencia de vinagre y 930 ml de agua. También puede utilizarse 1 l de agente descalcificante.



¡Precaución!

No vierta el agente descalcificante en recipientes para la recogida esmaltados u otros sensibles al ácido. Pueden dañarse.

- ▶ Asegúrese de que el recipiente para la recogida esté preparado para los agentes descalcificantes utilizados.
- ▶ Deseche el producto descalcificante de forma adecuada.



¡Advertencia!

Durante la descalcificación se produce vapor de vinagre. Si se inhala, resulta perjudicial para la salud.

- ▶ Asegúrese de que haya suficiente ventilación durante la descalcificación y no respire el vapor de vinagre.

DE

GB



FR

NL

ES

IT

Iniciar el proceso de descalcificación

- ▶ Seleccione el botón  en la pantalla.
- ▶ Con   cambie a **Eliminar la cal** y confirme con **OK**.
- ▶ Siga las instrucciones en pantalla.

DE



¡Advertencia!

Lesiones causadas por restos de la solución descalcificadora en el depósito de agua.

- ▶ Vacíe completamente el depósito de agua antes de volver a llenarlo para enjuagarlo.

GB



FR

Después de unos 20 minutos, se completa el proceso de descalcificación.

NL

Enjuague

Por razones de higiene, después de periodos largos sin utilizar el aparato, enjuáguelo antes de utilizarlo.

- ▶ Seleccione el botón  en la pantalla.
- ▶ Con   cambie a **enjuague** y confirme con **OK**.
- ▶ Siga las instrucciones en pantalla.

ES

IT

Limpieza



¡Advertencia!

Riesgo de lesiones por descarga eléctrica.

- ▶ Saque el enchufe antes de realizar la limpieza.



¡Atención!

Daños en el aparato debidos a una limpieza inadecuada.

- ▶ No sumerja el aparato en agua.
 - ▶ No limpie el aparato bajo el grifo.
 - ▶ El aparato no puede lavarse en el lavavajillas.
- ▶ Desenchufe el aparato y deje que se enfríe.
 - ▶ Limpie la superficie con un paño suave sin pelusa.
 - ▶ Levante el filtro giratorio y retire el conjunto del filtro. Deseche el filtro de papel con el café molido usado.

- ▶ Limpie el depósito de agua, el conjunto del filtro, el anillo del filtro y el filtro de dorado con agua de con jabón y séquelos.
- ▶ Limpie la jarra de cristal después de usarla con agua tibia y jabón y séquela.



Atención

Daños en la jarra térmica debidos a una limpieza inadecuada.

- ▶ No sumerja la jarra térmica en agua.
- ▶ La jarra térmica no puede lavarse en el lavavajillas.
- ▶ Limpie la jarra térmica por dentro y por fuera con un paño húmedo y séquela.
- ▶ Limpie la tapa del depósito para grano y el filtro oscilante con un paño húmedo y séquelos.

La jarra de vidrio, el conjunto del filtro, el anillo del filtro y el filtro de dorado también se pueden lavar en el lavavajillas.

Limpiar salida del café molido

Por razones de higiene, limpie regularmente la salida del café molido (se recomienda semanalmente).

- ▶ Seleccione el botón  en la pantalla.
- ▶ Con   cambie a **salida del café molido** y confirme con **OK**.

Para recoger los restos de café molido que caen: Coloque el recipiente debajo de la salida de café molido.

- ▶ Siga las instrucciones en pantalla.

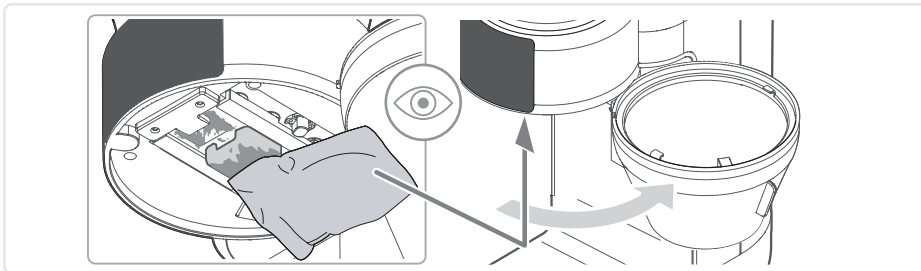

DE

GB

FR

NL

ES

IT

Limpieza del molinillo y del depósito para el grano

Limpie regularmente el molinillo y el depósito para el grano (recomendación: en caso de suciedad visible o después de cambiar el tipo de grano).

- ▶ Desenchufe el aparato y deje que se enfríe.
- ▶ Retire los granos de café del depósito para el grano.
- ▶ Desenrosque el depósito para el grano girando hacia la izquierda y retírelo.
- ▶ Elimine los restos de granos de café con una aspiradora de mano.
- ▶ Abra el la abrazadera del conjunto del molinillo, gírelo hacia la izquierda y retírelo.

Solo se puede girar el conjunto, no el molino en sí.

- ▶ Limpie el conjunto del molinillo y el molinillo con un cepillo.
- ▶ Coloque el conjunto del molinillo y bloquéelo girando hacia la derecha.
- ▶ Limpie el depósito para grano con un paño húmedo, limpie la tapa con agua de con jabón y seque bien ambos.
- ▶ Coloque el depósito para grano (🔒) y gírelo hacia la izquierda (🔓).
- ▶ Ajuste el grado de molienda deseado en el siguiente proceso de molienda.

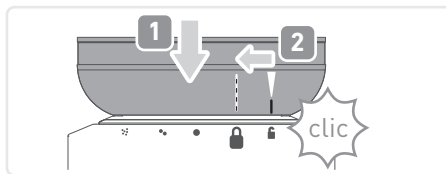

7 Transporte/almacenamiento

- ▶ Limpie y enjuague el aparato, consulte el capítulo 6, *Limpieza y cuidado*.
- ▶ Almacene el aparato en un lugar seco.

8 FAQ



¡Advertencia!

Riesgo de lesiones por el funcionamiento de un aparato defectuoso. El funcionamiento de un aparato defectuoso puede provocar descargas eléctricas.

- ▶ No utilice nunca un aparato defectuoso.
- ▶ No repare el dispositivo usted mismo, póngase en contacto con el servicio técnico de Severin.

Antes de ponerse en contacto con nuestro servicio de asistencia técnica, compruebe si puede solucionar el problema usted mismo con ayuda de la siguiente tabla.

Pregunta/problema	Solución
El café es demasiado claro.	El grado de molido está ajustado muy grueso. ▶ Ajuste el grado de molido más fino, consulte el capítulo4, <i>Antes de la primera puesta en marcha/ Grado de molido.</i>
No sale café del filtro oscilante.	La jarra para el café no está correctamente colocada debajo de la boquilla de salida. ▶ Coloque la cafetera correctamente sobre la placa calefactora y compruebe si se abre la válvula de la salida.
Parpadean todos los indicadores	El aparato tiene un fallo. ▶ Póngase en contacto con el servicio de atención al cliente.

Indicador	Problema/solución
	Falta agua. ▶ Rellene el depósito para el agua y pulse el botón
	El dispositivo debe ser descalcificado. ▶ Descalcificar el aparato, consulte la página 81, <i>Limpieza y cuidado Eliminar la cal.</i>

DE

GB

FR

NL

ES

IT

DE

GB

FR

NL

ES

IT

Indicador**Problema/solución**

El aparato se está descalcificando.
▶ Siga las instrucciones en la pantalla.



El depósito para grano no está colocado correctamente.
▶ Saque el enchufe de red y monte correctamente el depósito para grano, consulte el capítulo 6, *Limpeza y cuidado | Limpiar el molinillo*.

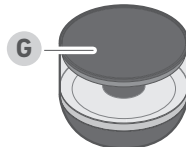
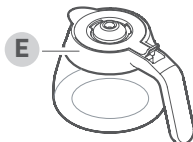
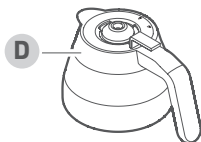
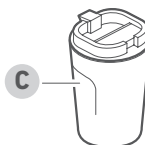
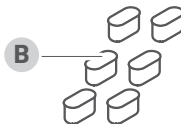
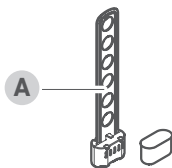

Aparato defectuoso.
▶ Póngase en contacto con el servicio de atención al cliente. Para ello, escanee el código QR.

9 Accesorios

- A** Soporte de filtro de agua con cartucho de filtro de agua (n.º art. 5562.000)
- B** Cartuchos de filtro de agua, 6 unidades (n.º art. 5557.000)
- C** Taza térmica «To-Go» (n.º art. 5555.000)
- D** Jarra térmica (acero inoxidable n.º art. 5554.000 / Dark-Inox n.º art. TK 5571.000)
- E** Jarra de vidrio (acero inoxidable n.º art. 5553.000/ Dark-Inox n.º art. GK 5556.000)
- F** Filtro Goldton (n.º art. 5561.000)
- G** Recipiente de repuesto de alubias para la sustitución flexible de alubias (acero inoxidable n.º art. ZB 5572.000 / Dark-Inox n.º art. ZB 5573.000)

DE

GB

FR

NL

ES

IT

10 Eliminación



Los aparatos identificados con este símbolo deben eliminarse por separado de la basura doméstica. Estos aparatos contienen materia prima valiosa que puede reutilizarse. La eliminación correcta de residuos protege el medio ambiente y la salud de los demás. El organismo local responsable o su distribuidor especializado le proporcionarán información sobre la eliminación adecuada.

11 Especificaciones técnicas

Número de artículo	KA 4852, KA 4853, KA 4854, KA 4855
Potencia	1.280 – 1.520 W
Capacidad del depósito de agua	2 l
Capacidad del depósito para grano	235 g
Medidas /...	46 x 38,2 x 17 cm
Peso neto	5,6 kg

Sommario

	1	Informazioni sulle presenti istruzioni	89
	2	Ambito della fornitura	90
DE	3	Display e pannello di controllo	91
GB	4	Al primo utilizzo	92
		Disimballaggio	92
FR		Pulizia	92
		Installazione	92
NL		Impostazioni	92
		Ripristino della lingua	94
ES	5	Preparazione del caffè	97
IT	6	Pulizia e cura	98
		Decalcificazione	98
		Pulizia	99
	7	Trasporto/Stoccaggio	101
	8	DOMANDE FREQUENTI	102
	9	Accessori	103
	10	Smaltimento	104
	11	Dati tecnici	104

1 Informazioni sulle presenti istruzioni

Informazioni generali

Le presenti istruzioni sono parte integrante dell'apparecchio.

- ▶ Leggerle attentamente prima del posizionamento, dell'installazione e della messa in funzione dell'apparecchio e conservarle per eventuali riferimenti futuri.
- ▶ In caso di cessione dell'apparecchio, consegnarle al nuovo utente.

L'apparecchio può essere utilizzato esclusivamente da persone che conoscono bene le informazioni di sicurezza.

Altri documenti allegati

- Guida introduttiva
- Manuale di sicurezza (Safety)
- Dichiarazione di garanzia (Warranty)

Visualizzazione delle avvertenze



Parola di segnalazione

Tipo, origine e conseguenze del pericolo

- ▶ Misure per evitare il pericolo.

Parola di segnalazione	Significato
Pericolo	Situazione di pericolo imminente che, se non viene evitata, provoca la morte o gravi lesioni.
Avvertenza	Pericolo potenzialmente imminente che, se non evitato, può causare la morte o lesioni gravi.
Attenzione	Pericolo potenzialmente imminente che, se non evitato, può provocare lesioni lievi.
Avviso	Pericolo potenzialmente imminente che, se non evitato, può causare danni materiali.

DE

GB

FR

NL

ES

IT

DE

GB

FR

NL

ES

IT

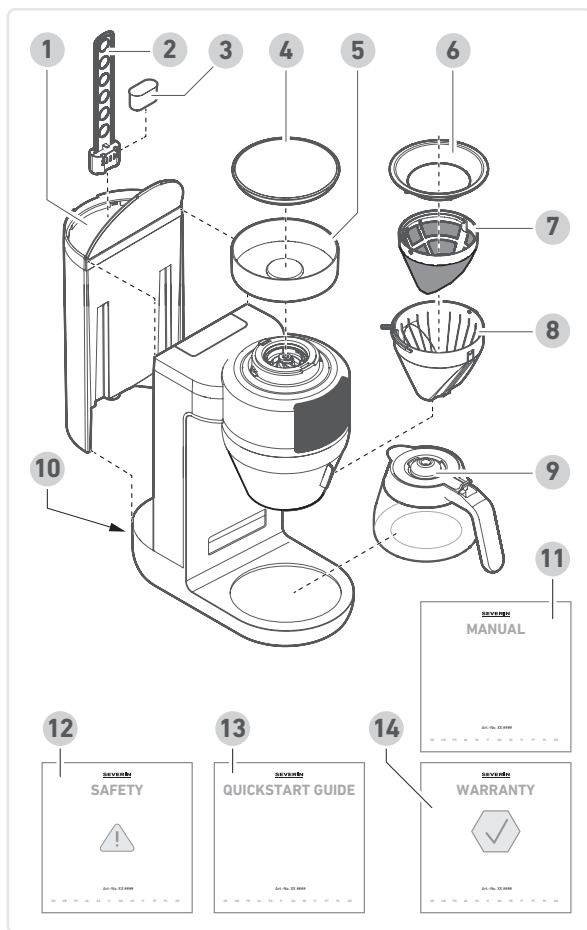

2 Ambito della fornitura

- 1 Serbatoio
- 2 Supporto del filtro dell'acqua
- 3 Cartuccia del filtro dell'acqua
- 4 Coperchio del contenitore dei chicchi
- 5 Contenitore dei chicchi
- 6 Guarnizione del filtro
- 7 Filtro dorato
- 8 Portafiltro
- 9 Caraffa
- 10 Interruttore di accensione/ spegnimento
- 11 Manuale
- 12 Avvertenze di sicurezza
- 13 Guida introduttiva
- 14 Dichiarazione di garanzia



www.severin.com

3 Display e pannello di controllo

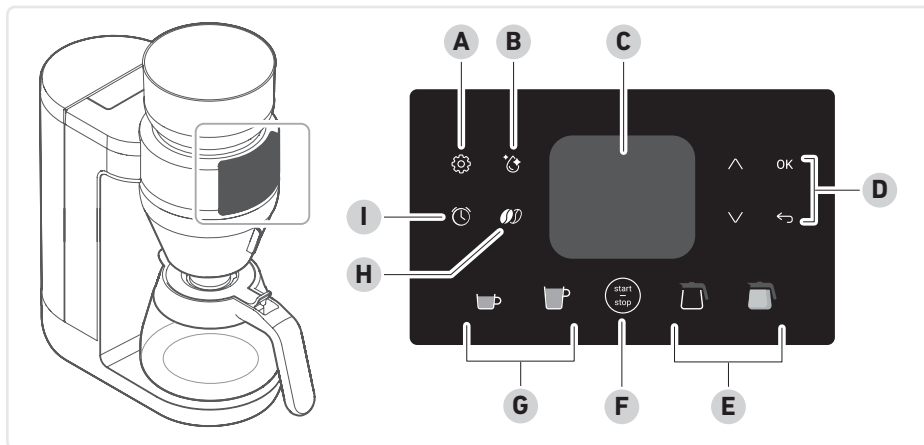

A Impostazioni: Chicchi/polvere, segnali acustici, filtro dell'acqua, durezza dell'acqua, ora, istruzioni, lingua, esperto, mantenere il calore, ripristino

B Pulizia: Risciacquo, decalcificazione, erogatore del macinato

C Display

D Navigazione: ▲▼ per selezionare le diverse opzioni di impostazione, OK per confermare, ⏪ per tornare alla voce di menu precedente o per uscire dal menu

E Tipo di caraffa: caraffa in vetro o thermos (a seconda della variante)

F avvio - stop: per avviare e arrestare l'erogazione del caffè, per l'attivazione in modalità standby

G Dimensione tazza: Tazza piccola: 100 - 150 ml, tazza grande: 175 - 350 ml in incrementi di 25 ml

H Intensità dell'aroma del caffè

I Sveglia

DE

GB

FR

NL

ES

IT

4 Al primo utilizzo

Disimballaggio

- ▶ Rimuovere tutti i componenti dall'imballaggio.
- ▶ Rimuovere tutto il materiale di imballaggio, le pellicole protettive e gli adesivi.
 - ! **Non rimuovere le targhette identificative in quanto devono rimanere sempre sull'apparecchio.**
- ▶ Verificare che la fornitura sia completa e che i componenti non presentino difetti.

Pulizia

- ▶ Pulire tutti gli accessori, vedere Capitolo 6 Pulizia e cura.
- ▶ Eseguire tre risciacqui, vedi pagina 99, *Risciacquo*.

Installazione



- ▶ Posizionare l'apparecchio su una superficie piana, asciutta, impermeabile e resistente al calore.
- ▶ Non posizionare l'apparecchio direttamente su marmo o legno (rischio di macchie di caffè/ anticalcare).
- ▶ Tenere l'apparecchio lontano da superfici calde (ad es. piastre di cottura).
- ▶ Inserire la spina di alimentazione in una presa con messa a terra.
- ▶ Azionare l'interruttore posto in basso sul retro dell'unità per accendere l'apparecchio.

Impostazioni

Prima della prima messa in funzione o dopo il ripristino delle impostazioni di fabbrica, il display presenta un'introduzione alle funzioni e alle icone selezionabili. Seguire le istruzioni sul display. In alternativa, le impostazioni possono essere modificate come segue:

Impostazioni generali

Segnali acustici





- ▶ Selezionare  sul display.
- ▶ Premere   per passare all'opzione **Segnali acustici** e confermare con **OK**.
- ▶ Seguire le istruzioni sul display, confermare con **OK** e premere  per tornare al menu principale.

Filtro dell'acqua

Il dispositivo può essere utilizzato con o senza filtro dell'acqua.

Durante il funzionamento senza filtro dell'acqua, regolare la durezza dell'acqua, *Durezza dell'acqua* vedi pagina 93, *Durezza dell'acqua*.



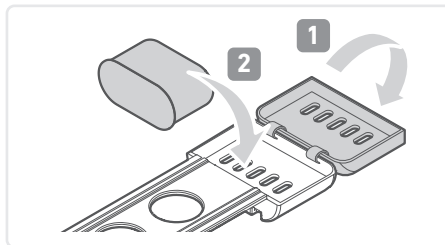

Sostituire il filtro dell'acqua ogni 2 mesi o dopo una quantità di caffè di circa 50 litri.

- ▶ Inserire la cartuccia del filtro nel supporto.
- ▶ Inserire il supporto del filtro nel serbatoio dell'acqua vuoto.
- ▶ Riempire il serbatoio dell'acqua con acqua e attendere almeno 10 minuti prima dell'uso.
- ▶ Selezionare  sul display.
- ▶ Premere   per passare alla voce **Filtro dell'acqua** e confermare con **OK**.
- ▶ Seguire le istruzioni sul display, confermare con **OK** e premere  per tornare al menu principale.



Durezza dell'acqua

Regolare la durezza dell'acqua solo se non si utilizza il filtro dell'acqua.

- ▶ Selezionare  sul display.
- ▶ Premere   per passare alla **Durezza dell'acqua** e confermare con **OK**.
- ▶ Seguire le istruzioni sul display, confermare con **OK** e premere  per tornare al menu principale.

Durezza dell'acqua



dolce



media



dura

DE

GB





FR

NL

ES

IT

Ora

- ▶ Selezionare  sul display.
- ▶ Premere   per passare alla voce **Ora** e confermare con **OK**.
- ▶ Seguire le istruzioni sul display, confermare con **OK** e premere  per tornare al menu principale.

DE

GB

Istruzioni per l'uso

- ▶ Selezionare  sul display.
- ▶ Premere   per accedere alle **Istruzioni** e confermare con **OK**.
- ▶ Scansionare il codice QR e accedere alle istruzioni.

FR

NL

Lingua

- ▶ Selezionare  sul display.
- ▶ Premere   per accedere alla voce **Lingua** e confermare con **OK**.
- ▶ Seguire le istruzioni sul display, confermare con **OK** e premere  per tornare al menu principale.





ES

IT

Ripristino delle impostazioni di fabbrica (impostazioni predefinite)

- ▶ Selezionare  sul display.
- ▶ Premere   per passare a **Ripristino** e confermare due volte con **OK**.

È stata selezionata la lingua errata?

- ▶ Tornare al menu principale con .
- ▶ Premere  quindi utilizzare   per scorrere fino in fondo (barra grigia in basso sul display) e confermare con **OK**.

Se ciò non risolve il problema, premere ripetutamente **OK** fino a visualizzare il menu principale. Quindi, premere  e procedere come indicato sopra.

Le impostazioni dell'apparecchio vengono ripristinate ed è possibile scegliere nuovamente la lingua.

Modalità Standby

Dopo 5 minuti, l'apparecchio entra in modalità standby.

Sul display sono visibili solo l'ora e .

▶ Toccare  o aprire il portafiltro per uscire dalla modalità standby.



Impostazioni per la preparazione del caffè

Chicchi/polvere

- ▶ Selezionare  sul display.
- ▶ Passare a **Chicchi/polvere** e confermare con **OK**.
- ▶ Selezionare **Chicchi** o **Polvere**, confermare con **OK** e tornare al menu principale con .

Intensità dell'aroma del caffè

Quanto di utilizzano chicchi di caffè, l'intensità del caffè può essere regolata in 5 livelli dopo aver impostato il recipiente:

- ▶ Premere il pulsante  per selezionare l'intensità del caffè, quindi premere  per iniziare la preparazione.

Esperto





Nella modalità Esperto è possibile regolare manualmente l'intensità del caffè.

Il valore predefinito è 100%. Più bassa è l'impostazione, più leggero sarà il caffè.



Avvertenza!

Danni al dispositivo, alle superfici e ai mobili dovuti al trabocco del filtro.

- ▶ Con un'impostazione >130%, il numero di tazze per la preparazione con la caraffa non deve essere superiore a 6.
- ▶ Selezionare  sul display.
- ▶ Premere   per passare a **Esperto** e confermare con **OK**.
- ▶ Seguire le istruzioni sul display, confermare con **OK** e premere  per tornare al menu principale.

DE

GB

FR

NL

ES

IT

Grado di macinatura



Avvertenza!

Una modifica del grado di macinatura quando il macinino è spento può causare danni all'apparecchio.

- ▶ Modificare il grado di macinatura solo con il macinino acceso.

Il grado di macinatura può essere regolato in modo continuo.

- ▶ Ruotare il segno sul contenitore dei chicchi fino al grado di macinazione desiderato mentre il macinino è acceso.

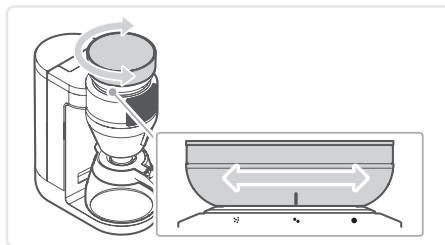

Sveglia

Per utilizzare la funzione "sveglia", l'ora deve essere impostata correttamente.







Se la funzione sveglia è attivata, il caffè viene preparato all'ora specificata nella quantità impostata. Al momento della preparazione, il dispositivo deve essere assemblato correttamente, i chicchi o la polvere di caffè e l'acqua devono essere riempiti in quantità sufficiente e deve esserci un recipiente adatto sotto l'erogatore.

- ▶ Selezionare  sul display.

- ▶ Seguire le istruzioni sul display, confermare con **OK** e premere  per tornare al menu principale.

Per utilizzare nuovamente la sveglia, la funzione deve essere riattivata. Le impostazioni vengono memorizzate.

Mantenere il calore

La funzione di mantenimento del calore con caraffa di vetro si avvia automaticamente dopo il processo di erogazione. La durata è impostata in fabbrica a 30 minuti. Premere   una volta per modificare la durata una singola volta (15-60 minuti). Per la modifica permanente del tempo di mantenimento in caldo, selezionare  sul display. Premere   per passare a **Mantenere il calore** e confermare con **OK**. Seguire le istruzioni sul display, confermare con **OK** e premere  per tornare al menu principale.

In alternativa, la funzione di mantenimento in caldo può essere avviata premendo a lungo .

DE

GB

FR

NL

ES

IT

5 Preparazione del caffè







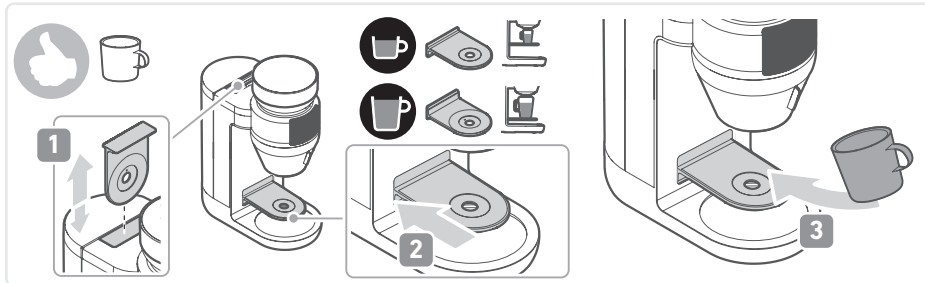
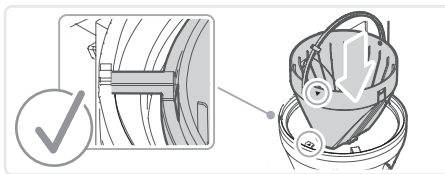

Avvertenza!

Pericolo di ustioni.

▶ Non tenere parti del corpo sotto l'erogatore mentre il dispositivo è in funzione.

- ▶ Riempire il serbatoio con un massimo di 2000 ml di acqua di rubinetto fredda.
- ▶ Montare il portafiltro.
- ▶ Inserire un filtro dorato o un filtro monouso.
- ▶ Posizionare la guarnizione del filtro.
- ▶ A seconda del metodo di preparazione scelto, versare i chicchi nel contenitore dei chicchi o la polvere di caffè nel filtro del caffè.
- ▶ Posizionare il recipiente desiderato sotto l'erogatore.



- ▶ Selezionare il recipiente sul display:    .
- ▶ Impostare la quantità ed eventualmente l'intensità del caffè.
- ▶ Avviare il processo di preparazione con .
- ▶ Per interrompere la preparazione, premere di nuovo il pulsante .

DE

GB

FR

NL

ES

IT

6 Pulizia e cura

Decalcificazione

DE

Il dispositivo deve essere decalcificato in base al contenuto di calcare dell'acqua e alla frequenza di utilizzo.

GB

Ogni copertura della garanzia sarà annullata e invalidata se i problemi di malfunzionamento dell'apparecchio sono dovuti alla mancata eliminazione dei residui calcarei.

FR

La spia  si illumina in rosso quando il dispositivo deve essere decalcificato. Il processo di decalcificazione dura circa 20 minuti.

NL

Per la decalcificazione sono necessari 70 ml di essenza di aceto e 930 ml di acqua. In alternativa, 1 l di decalcificante.

ES

IT



Attenzione!

Non versare il decalcificante in lavandini smaltati o sensibili agli acidi in quanto possono subire danni.

- ▶ Verificare che il lavandino sia predisposto per i decalcificanti utilizzati.
- ▶ Smaltire correttamente il decalcificante.



Avvertenza!

Durante la decalcificazione si forma vapore di aceto. Questo è dannoso per la salute se inalato.

- ▶ Durante la decalcificazione, garantire una ventilazione sufficiente e non inalare il vapore di aceto.

Avvio del processo di decalcificazione

- ▶ Premere il pulsante  sul display.
- ▶ Premere  per passare all'opzione di **decalcificazione** e confermare con **OK**.
- ▶ Seguire le istruzioni sul display.



Avvertenza!



Pericolo di lesioni causate da quantità residue di soluzione decalcificante nel serbatoio dell'acqua.

- ▶ Svuotare completamente il serbatoio dell'acqua prima di riempirlo nuovamente per il risciacquo.

Dopo circa 20 minuti, il processo di decalcificazione è completato.

Risciacquo

Per motivi di igiene, sciacquare l'apparecchio se non è stato utilizzato da lungo tempo.

- ▶ Premere il pulsante  sul display.
- ▶ Premere  per accedere all'opzione **Risciacquo** e confermare con **OK**.
- ▶ Seguire le istruzioni sul display.

Pulizia



Avvertenza!

Pericolo di lesioni dovute a scosse elettriche.

- ▶ Scollegare sempre la spina di alimentazione prima della pulizia.



Attenzione!

Pericolo di danni al dispositivo a causa di una pulizia impropria.

- ▶ Non immergere l'apparecchio in acqua.
 - ▶ Non pulire l'apparecchio sotto l'acqua corrente.
 - ▶ Non lavare l'apparecchio in lavastoviglie.
- ▶ Estrarre la spina di alimentazione e lasciare raffreddare l'apparecchio.
 - ▶ Pulire la superficie con un panno morbido privo di lanugine.
 - ▶ Aprire il gruppo filtro e rimuovere il portafiltro. Smaltire il filtro di carta con il caffè macinato usato.

DE

GB

FR

NL

ES

IT

- ▶ Pulire e asciugare il serbatoio dell'acqua, il portafiltro, la guarnizione e il filtro dorato con acqua e detergente per piatti.
- ▶ Dopo l'uso, pulire la caraffa di vetro con acqua calda e detergente, quindi asciugarla.

DE



Attenzione

Pericolo di danni al thermos se pulito in modo improprio.

- ▶ Non immergere il thermos in acqua.
- ▶ Non lavarle il thermos in lavastoviglie.

GB

FR

- ▶ Risciacquare l'interno, quindi pulire l'esterno con un panno umido e asciugare.
- ▶ Pulire l'interno e l'esterno del coperchio del contenitore dei chicchi con un panno umido, quindi asciugare.

NL

La caraffa in vetro, il portafiltro, la guarnizione e il filtro dorato possono essere lavati anche in lavastoviglie.

ES

IT

Pulizia dell'erogatore del macinato

Per motivi igienici, pulire regolarmente l'erogatore del macinato (raccomandazione: ogni settimana).

- ▶ Premere il pulsante  sul display.
- ▶ Premere   per passare all'opzione **Erogatore del macinato** e confermare con **OK**.

Per raccogliere i residui di polvere di caffè che cadono: posizionare il recipiente sotto l'erogatore del macinato.

- ▶ Seguire le istruzioni sul display.

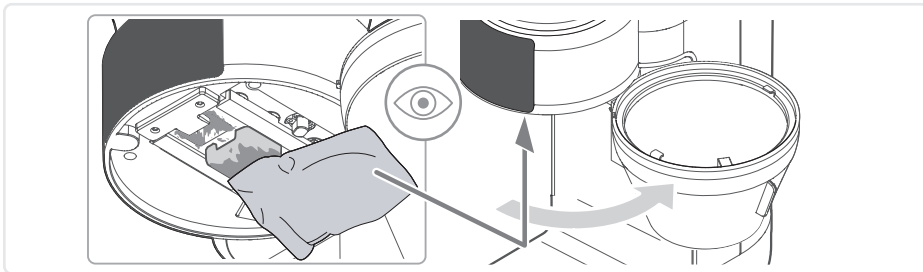

Pulizia del macinacaffè e del contenitore dei chicchi

Pulire regolarmente il macinacaffè e il contenitore dei fagioli [raccomandazione: in caso di sporco visibile o dopo aver cambiato la varietà di chicchi].

- ▶ Estrarre la spina di alimentazione e lasciare raffreddare l'apparecchio.
- ▶ Rimuovere i chicchi di caffè dal contenitore.
- ▶ Aprire il contenitore dei chicchi in senso antiorario e rimuoverlo.
- ▶ Rimuovere i residui di chicchi di caffè con un mini aspirapolvere.
- ▶ Aprire la staffa sull'inserto del macinacaffè e ruotare il macinacaffè in senso antiorario per estrarlo.

È possibile ruotare solo l'inserto, non il macinacaffè stesso.

- ▶ Pulire l'inserto e il macinacaffè con un pennello.
- ▶ Inserire l'inserto del macinacaffè e bloccarlo ruotandolo in senso orario.
- ▶ Pulire il contenitore dei chicchi con un panno umido, lavare il coperchio con acqua e detergente per piatti, quindi asciugare accuratamente entrambi.
- ▶ Posizionare il contenitore dei chicchi (🔒) e ruotarlo verso sinistra (🔒).
- ▶ Impostare il grado di macinatura desiderato al successivo processo di macinatura.

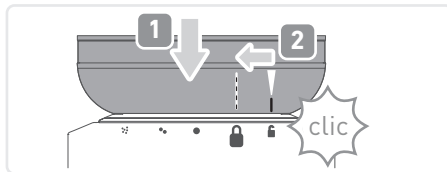

7 Trasporto/Stoccaggio

- ▶ Pulire e risciacquare l'apparecchio, vedere il capitolo 6, *Pulizia e cura*.
- ▶ Conservare l'apparecchio in un luogo asciutto.

DE

GB

FR

NL

ES

IT

8 DOMANDE FREQUENTI









Avvertenza!

Rischio di lesioni in caso di utilizzo di un apparecchio difettoso. La messa in funzione di un apparecchio difettoso può causare scosse elettriche.

- ▶ Non utilizzare mai un apparecchio difettoso.
- ▶ Non riparare l'apparecchio da soli, ma contattare il servizio di assistenza Severin.

Prima di contattare il nostro servizio di assistenza, utilizzare la seguente tabella per verificare se è possibile risolvere il problema da soli.

	Domanda / problema	Soluzione
DE	Il caffè è troppo leggero.	Il grado di macinatura è troppo grossolano. ▶ Scegliere un grado di macinatura più fine, vedere il capitolo 4, <i>Al primo utilizzo/Grado di macinatura</i> .
GB	Il caffè non fuoriesce dal gruppo filtro.	La caraffa di vetro non è sistemata correttamente sotto l'erogatore. ▶ Posizionare correttamente la caraffa sulla piastra riscaldante e verificare che la valvola di erogazione sia aperta.
FR	Tutti gli indicatori del display lampeggiano.	L'apparecchio è difettoso. ▶ Contattate il servizio di assistenza clienti.
NL		
ES		
IT		

Indicazione	Problema/soluzione
	<p>Quantità d'acqua insufficiente</p> <p>► Riempire il serbatoio dell'acqua e premere il pulsante .</p>
	<p>L'apparecchio deve essere decalcificato.</p> <p>► Decalcificare l'apparecchio, vedi pagina 98, <i>Pulizia e cura / Decalcificazione</i>.</p>
	<p>L'apparecchio viene decalcificato.</p> <p>► Seguire le istruzioni sul display.</p>
	<p>Contenitore dei chicchi non posizionato correttamente.</p> <p>► Staccare la spina di alimentazione e posizionare correttamente il contenitore dei chicchi, vedere il capitolo 6, <i>Pulizia e cura / Pulire il macinacaffè</i>.</p>
	<p>Dispositivo difettoso.</p> <p>► Contattate il servizio di assistenza clienti. A tale scopo, scansionare il codice QR.</p>

DE

GB

FR

NL

ES

IT

9 Accessori

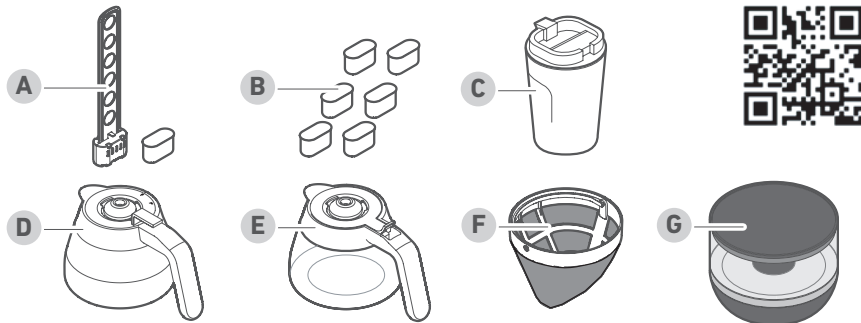

- A** Supporto filtro acqua con cartuccia filtro acqua (cod. art. 5562.000)
- B** Cartucce filtro acqua, 6 pezzi (cod. art. 5557.000)
- C** Tazza termica "To-Go" (cod. art. 5555.000)
- D** Caraffa termica (acciaio inox cod. art. 5554.000/ acciaio inox scuro cod. art. TK 5571.000)
- E** Caraffa in vetro (acciaio inox cod. art. 5553.000 /acciaio inox scuro cod. art. GK 5556.000)
- F** Filtro dorato (cod. art. 5561.000)
- G** Contenitore di ricambio per la sostituzione flessibile dei fagioli (acciaio inox cod. art. ZB 5572.000 / acciaio inox scuro cod. Art. ZB 5573.000)

10 Smaltimento



I dispositivi contrassegnati da questo simbolo devono essere smaltiti separatamente dai rifiuti domestici. Questi dispositivi contengono materie prime preziose che possono essere riciclate. Un corretto smaltimento protegge l'ambiente e la salute del prossimo. Le proprie autorità locali o il proprio rivenditore specializzato possono fornire informazioni sul corretto smaltimento.

11 Dati tecnici

Codice articolo	KA 4852, KA 4853, KA 4854, KA 4855
Potenza	1.280 – 1.520 W
Capacità serbatoio acqua	2 l
Capacità contenitore chicchi	235 g
Dimensioni	46 x 38,2 x 17 cm
Peso netto	5,6 kg

SERVICE



SEVERIN global

SEVERIN Service Deutschland

Tel +49 2933 982-1460

service@severin.de

FOLLOW US ON



www.severin.com/socials

SEVERIN

SEVERIN Elektrogeräte GmbH

Röhre 27

D-59846 Sundern

Tel +49 2933 982-0

information@severin.de

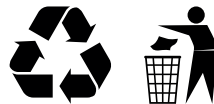

MANUAL V1 KA 4852, 4853, 4854, 4855 **08/24**

Technische Änderungen vorbehalten. /

Model specifications are subject to change.